



PORTAS SECCIONADAS

PUERTAS SECCIONALES
PORTES SECTIONNELLES
SECTIONAL DOORS

ÍNDICE

ÍNDICE / INDICE / INDEX

A EMPRESA LA EMPRESA LA SOCIÉTÉ THE COMPANY

04

PORTAS PUERTAS PORTES DOORS

05

LM SABLÉ BLANC

06

LM SABLÉ NOIR

08

LM SABLÉ

10

LM SILVER

12

LM INOX

14

LM CORTEN

16

LM LISO LISO / LISO LISO
LISSE LISSE / SUPER FLAT

18

LM FRISO ÚNICO LISO / UNICANELADO LISO
MONO LIGNE LISSE / CENTRE RIBBED SUPER FLAT

20

LM FRISO ÚNICO WOODGRAIN / UNICANELADO WOODGRAIN
MONO LIGNE WOODGRAIN / CENTRE RIBBED WOODGRAIN

22

LM CANELADO LISO / ACANELADO LISO
RAINURÉ LISSE / RIBBED SUPER FLAT

24

LM CANELADO WOODGRAIN / ACANELADO WOODGRAIN
RAINURÉ WOODGRAIN / RIBBED WOODGRAIN

26

LM MICRO-FRISO / MICROACANALADO
MICRONERVURÉ / MICRO RIBBED

28

LM ALMOFADADO WOODGRAIN/ CUARTERONES WOODGRAIN
CASSETTE WOODGRAIN / PANELLED WOODGRAIN

30

LM SEA WOODGRAIN

32

LM CANELADO ALUMÍNIO / LM ACANALADO ALUMINIO
LM RAINURÉ ALUMINIUM / LM RIBBED ALUMINIUM

34

LM ALU

36

LM ALU
ACABAMENTOS / ACABADOS / FINITIONS / FINISHES

38

LM 80

40

LM SLIM | PORTA-HOMEM SECCIONADO / LM SLIM | PUERTA PEATONAL
LM SLIM | PORTILLON / LM SLIM | WICKET DOOR

42

PORTA-HOMEM ECLIPSE / PUERTA PEATONAL ECLIPSE
PORTILLON ECLIPSE / WICKET DOOR ECLIPSE

44

PORTA DE SERVIÇO LATERAL / PUERTA PEATONAL LATERAL
PORTE PIÉTONNÉ LATÉRALE / PEDESTRIAN LATERAL DOOR

46

CARACTERÍSTICAS TÉCNICAS CARACTERÍSTICAS TÉCNICAS CARACTÉRISTIQUES TECHNIQUES TECHNICAL SPECIFICATIONS

48

CONFIGURAÇÃO EASY SPRING - MOLAS LATERAIS
CONFIGURACIÓN EASY SPRING - MUELLES LATERALES
CONFIGURATION EASY SPRING - RESSORTS LATÉRAUX
EASY SPRING CONFIGURATION - LATERAL SPRINGS

50

CONFIGURAÇÃO DE PORTAS SECCIONADAS
CONFIGURACIÓN DE PUERTAS SECCIONADAS
CONFIGURATION DES PORTES SECTIONNELLES
SECTIONAL DOOR CONFIGURATION

52

CALHAS PARA PORTAS SECCIONADAS
GUIAS PARA PUERTAS SECCIONALES
RAILS POUR PORTES SECTIONNELLES
SECTIONAL DOOR OPTIONS FOR RAILS

54

OPÇÕES E ACESSÓRIOS DE PORTAS SECCIONADAS
OPCIONES Y ACCESORIOS PARA PUERTAS SECCIONALES
OPTIONS ET ACCESSOIRES POUR PORTES SECTIONNELLES
SECTIONAL DOOR OPTIONS AND ACCESSORIES

60

OPÇÕES E ACESSÓRIOS PORTA DE SERVIÇO LATERAL
OPCIONES Y RECAMBIOS PUERTA PEATONAL LATERAL
OPTIONS ET ACCESSOIRES PORTE PIÉTONNÉ LATÉRALE
OPTIONS & SPARES PEDESTRIAN LATERAL DOOR

60

OMBREIRAS FALSAS / PREMARCOS
FAUX ÉCOINÇONS / JAMB POSTS

61

PADIEIRAS FALSAS / DINTELES FALSOS
FAUX LINTEAUX / LINTEL FASCIAS

62

CONFIGURAÇÃO DE PORTAS ECLIPSE
CONFIGURACIÓN DE LA PUERTA ECLIPSE
CONFIGURATION DE LA PORTE ECLIPSE
ECLIPSE DOOR CONFIGURATION

64

CONFIGURAÇÃO DE MOTORIZAÇÃO ECLIPSE
CONFIGURACIONES DE MOTORIZACIÓN ECLIPSE
CONFIGURATIONS DE MOTORISATION ECLIPSE
AUTOMATED DOOR CONFIGURATION ECLIPSE

66

OPÇÕES E ACESSÓRIOS - ECLIPSE
OPCIONES Y ACCESORIOS PARA PUERTAS ECLIPSE
OPTIONS ET ACCESSOIRES POUR PORTES ECLIPSE
OPTIONS AND ACCESSORIES - ECLIPSE

67

LUSO 40/80 PAINEL PANEL PANNEAU PANEL

68

VISORES / MIRILLAS
HUBLOTS / GLAZING

74

VISORES E VENTILADORES / MIRILLAS Y VENTILADORES
HUBLOTS ET GRILLES / GLAZING AND VENTILATION

76

SKYMASTER AUTOMAÇÃO AUTOMACIÓN AUTOMATION AUTOMATION

78

SKY NX
MOTOR DE TETO
MOTOR DE TECHO
MOTEUR DE PLAFOND
CEILING MOTOR

79

F-330
MOTOR DE TETO
MOTOR DE TECHO
MOTEUR DE PLAFOND
CEILING MOTOR

80

F-350
MOTOR DE TETO
MOTOR DE TECHO
MOTEUR DE PLAFOND
CEILING MOTOR

81

F-390
MOTOR DE TETO
MOTOR DE TECHO
MOTEUR DE PLAFOND
CEILING MOTOR

82

F-850T
MOTOR AO VEIO
MOTOR AL EJE
MOTEUR EN BOUT D'ARBRE
GEAR MOTOR

83

F-850BX
F-850BX
F-850E
MOTOR AO VEIO
MOTOR AL EJE
MOTEUR EN BOUT D'ARBRE
GEAR MOTOR

84

F-140
MOTOR AO VEIO
MOTOR AL EJE
MOTEUR EN BOUT D'ARBRE
GEAR MOTOR

85

SKYMASTER
OPÇÕES E ACESSÓRIOS / OPCIONES Y ACCESORIOS
OPTIONS ET ACCESSOIRES / OPTIONS AND ACCESSORIES

86

ENCOMENDAS
PEDIDOS
COMMANDES
ORDERS

88

CONTACTOS
CONTACTO
CONTACT
CONTACTS

88

TRANSPORTE
ENTREGAS
LIVRAISON
DELIVERY

89

APOIO AO CLIENTE
SERVICIO AL CLIENTE
SERVICE CLIENT
CUSTOMER SERVICE

89

CONTACTOS
CONTACTO
CONTACT
CONTACTS

89

A EMPRESA

LA EMPRESA / LA SOCIÉTÉ / THE COMPANY

PT

Com mais de 30 anos de experiência, a LM Perfis S.A. destaca-se pela qualidade, inovação e fiabilidade no setor dos portões seccionados e automatismos. A seleção criteriosa de produtos complementares demonstra o nosso compromisso em proporcionar soluções práticas, seguras e esteticamente apelativas.

Ao longo dos anos, afirmámo-nos como uma empresa de referência, reconhecida pelo rigor, profissionalismo e capacidade de adaptação às exigências do mercado.

ES

Con más de 30 años de experiencia, LM Perfis S.A. se distingue por su calidad, innovación y fiabilidad en el sector de las puertas seccionales y automatismos. Una cuidada selección de productos complementarios refleja nuestro compromiso de ofrecer soluciones prácticas, seguras y estéticamente atractivas.

A lo largo de los años, nos hemos consolidado como una empresa de referencia, reconocida por su rigor, profesionalismo y capacidad de adaptación a las exigencias del mercado.

FR

Avec plus de 30 ans d'expérience, LM Perfis S.A. se distingue par sa qualité, son innovation et sa fiabilité dans le secteur des portes sectionnelles et des automatismes. Une sélection rigoureuse de produits complémentaires reflète notre engagement à offrir des solutions pratiques, sûres et esthétiques.

Au fil des années, nous nous sommes imposés comme une entreprise de référence, reconnue pour sa rigueur, son professionnalisme et sa capacité d'adaptation aux exigences du marché.

IN

With over 30 years' experience, LM Perfis S.A. stands out for its quality, innovation and reliability in the sectional door and automation sector. Our careful selection of complementary products demonstrates our commitment to providing practical, safe and aesthetically pleasing solutions.

Over the years, we have established ourselves as a leading company, recognised for our rigour, professionalism and ability to adapt to market demand.



PORTAS

PUERTAS / PORTES / DOORS



**Painel Standard
Panel Estándar
Panneau Standard
Standard Panel**



PS.040CA29	branco blanco blanc white	RAL 9010	€/m ²
-------------------	------------------------------------	----------	------------------

*O painel não pode ser pintado
Panel no se puede pintar
Le panneau ne peut pas être peint
Panel can not be painted

**Painel Standard
Panel Estándar
Panneau Standard
Standard Panel**



PL.040CA29	branco blanco blanc white	RAL 9010	€/m ²
-------------------	------------------------------------	----------	------------------

*O painel não pode ser pintado
Panel no se puede pintar
Le panneau ne peut pas être peint
Panel can not be painted



PT

Painel sandwich

Em secções de 500mm ou 610mm de altura útil e espessura de 40mm
Interior em poliuretano expandido de alta densidade e isento de CFC
Encaixe anti-dedo prevenindo qualquer hipótese de entalamento durante a operação do portão
Vedante em EPDM embutido no macho do painel
Chapas de reforço em aço galvanizado, inferior e superior, no interior do painel
Grande isolamento térmico e acústico

Cara exterior

Chapa de aço de 0,4mm pré-lacada e com tratamento anti-oxidação
Textura sablé

Cara interior

Chapa de aço de 0,4mm pré-lacada e com tratamento anti-oxidação
Canelado fino e textura 'stucco', branco RAL 9010

Faturação mínima: 5,5 m²

ES

Panel sandwich

Con secciones de 500mm o 610mm de altura útil y espesor de 40mm
Interior de poliuretano expandido de gran densidad y libre de CFC
Encaje antipinzamiento preveniendo cualquier situación de riesgo durante su movimentación
Goma de EPDM incrustada en el macho del panel
Área de refuerzo, inferior y superior, de acero galvanizado, en el interior del panel
Gran aislamiento térmico y acústico

Cara exterior

Chapa de acero de 0,4mm prelacada y con tratamiento antioxidación
Texturado

Cara interior

Chapa lisa de acero de 0,4mm prelacada y con tratamiento antioxidación
Acanalado fino y textura 'stucco', blanco RAL 9010

Facturación mínima: 5,5 m²



FR

Panneau sandwich

En section de 500mm ou 610mm de hauteur utile et épaisseur de 40mm
 Intérieur en polyuréthane à haute densité et dépourvu de CFC
 Emboîtement anti-pince doigt, évitant toute possibilité de coincement pendant la marche de la porte
 Plaques de renfort en acier galvanisé, inférieures et supérieures, à l'intérieur du panneau
 Joint EPDM encastré dans la partie mâle du panneau
 Forte isolation thermique et acoustique

Coté extérieur

Tôle d'acier lisse de 0,4mm pré-laqué et avec traitement antioxydant
 Texture sablé

Coté intérieur:

Tôle d'acier de 0,4mm pré-laqué et avec traitement antioxydant
 Rainuré fin et texture 'stucco', blanc RAL 9010

Minimum de facturation: 5,5 m²

EN

Sandwich panel

In sections of 500mm or 610mm height and thickness of 40mm
 Interior of high density expanded polyurethane, CFC free
 Safe-finger interlocking system preventing any trapping episodes during door's moving cycle
 EPDM rubber seal grooved into the panel's top
 Reenforced panel's structure with galvanized steel strips in top and bottom ends of the panel
 Great thermal and acustic insulation

Outer appearance:

0,4mm galvanized steel plate, pre-powdercoated and with anti-corrosion treatment
 Textured

Inner appearance:

0,4mm galvanized steel plate, pre-powdercoated and with anti-corrosion treatment
 Thin ribbed pattern and 'stucco' emboss, pre-powdercoated white RAL 9010

Minimum charge: 5,5 m²

Painel Standard
Panel Estándar
Panneau Standard
Standard Panel



PS.040CA28

preto
negro
noir
black

RAL 9005

€/m²

*O painel não pode ser pintado
 Panel no se puede pintar
 Le panneau ne peut pas être peint
 Panel can not be painted

Painel Standard
Panel Estándar
Panneau Standard
Standard Panel



PL.040CA28

preto
negro
noir
black

RAL 9005

€/m²

*O painel não pode ser pintado
 Panel no se puede pintar
 Le panneau ne peut pas être peint
 Panel can not be painted



PT

Painel sandwich

Em secções de 500mm ou 610mm de altura útil e espessura de 40mm
 Interior em poliuretano expandido de alta densidade e isento de CFC
 Encaixe anti-dedo prevenindo qualquer hipótese de entalamento durante a operação do portão
 Vedante em EPDM embutido no macho do painel
 Chapas de reforço em aço galvanizado, inferior e superior, no interior do painel
 Grande isolamento térmico e acústico

Cara exterior

Chapa de aço de 0,4mm pré-lacada e com tratamento anti-oxidação
 Textura sablé

Cara interior

Chapa de aço de 0,4mm pré-lacada e com tratamento anti-oxidação
 Canelado fino e textura 'stucco', branco RAL 9010

Faturação mínima: 5,5 m²

ES

Panel sandwich

Con secciones de 500mm o 610mm de altura útil y espesor de 40mm
 Interior de poliuretano expandido de gran densidad y libre de CFC
 Encaje antipinzamiento preveniendo cualquier situación de riesgo durante su movimentación
 Goma de EPDM incrustada en el macho del panel
 Área de refuerzo, inferior y superior, de acero galvanizado, en el interior del panel
 Gran aislamiento térmico y acústico

Cara exterior

Chapa de acero de 0,4mm prelacada y con tratamiento antioxidación
 Texturado

Cara interior

Chapa liso de acero de 0,4mm prelacada y con tratamiento antioxidación
 Acanalado fino y textura 'stucco', blanco RAL 9010

Facturación mínima: 5,5 m²



FR

Panneau sandwich

En section de 500mm ou 610mm de hauteur utile et épaisseur de 40mm
 Intérieur en polyuréthane à haute densité et dépourvu de CFC
 Emboîtement anti-pince doigt, évitant toute possibilité de coincement pendant la marche de la porte
 Plaques de renfort en acier galvanisé, inférieures et supérieures, à l'intérieur du panneau
 Joint EPDM encastré dans la partie mâle du panneau
 Forte isolation thermique et acoustique

Coté extérieur

Tôle d'acier lisse de 0,4mm pré-laqué et avec traitement antioxydant
 Texture sablé

Coté intérieur:

Tôle d'acier de 0,4mm pré-laqué et avec traitement antioxydant
 Rainuré fin et texture 'stucco', blanc RAL 9010

Minimum de facturation: 5,5 m²

EN

Sandwich panel

In sections of 500mm or 610mm height and thickness of 40mm
 Interior of high density expanded polyurethane, CFC free
 Safe-finger interlocking system preventing any trapping episodes during door's moving cycle
 EPDM rubber seal grooved into the panel's top
 Reinforced panel's structure with galvanized steel strips in top and bottom ends of the panel
 Great thermal and acustic insulation

Outer appearance:

0,4mm galvanized steel plate, pre-powdercoated and with anti-corrosion treatment
 Textured

Inner appearance:

0,4mm galvanized steel plate, pre-powdercoated and with anti-corrosion treatment
 Thin ribbed pattern and 'stucco' emboss, pre-powdercoated white RAL 9010

Minimum charge: 5,5 m²

Painel Standard
Panel Estándar
Panneau Standard
Standard Panel

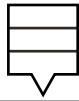

PS.040CA25

cinza
gris
gris
grey

RAL 7016

€/m²

*O painel não pode ser pintado
 Panel no se puede pintar
 Le panneau ne peut pas être peint
 Panel can not be painted

Painel Standard
Panel Estándar
Panneau Standard
Standard Panel



PL.040CA25

cinza
gris
gris
grey

RAL 7016

€/m²

*O painel não pode ser pintado
 Panel no se puede pintar
 Le panneau ne peut pas être peint
 Panel can not be painted



PT

Painel sandwich

Em secções de 500mm ou 610mm de altura útil e espessura de 40mm
 Interior em poliuretano expandido de alta densidade e isento de CFC
 Encaixe anti-dedo prevenindo qualquer hipótese de entalamento durante a operação do portão
 Vedante em EPDM embutido no macho do painel
 Chapas de reforço em aço galvanizado, inferior e superior, no interior do painel
 Grande isolamento térmico e acústico

Cara exterior

Chapa de aço de 0,4mm pré-lacada e com tratamento anti-oxidação
 Textura sablé

Cara interior

Chapa de aço de 0,4mm pré-lacada e com tratamento anti-oxidação
 Canelado fino e textura 'stucco', branco RAL 9010

Faturação mínima: 5,5 m²

ES

Panel sandwich

Con secciones de 500mm o 610mm de altura útil y espesor de 40mm
 Interior de poliuretano expandido de gran densidad y libre de CFC
 Encaje antipinzamiento preveniendo cualquier situación de riesgo durante su movimentación
 Goma de EPDM incrustada en el macho del panel
 Área de refuerzo, inferior y superior, de acero galvanizado, en el interior del panel
 Gran aislamiento térmico y acústico

Cara exterior

Chapa de acero de 0,4mm prelacada y con tratamiento antioxidación
 Texturado

Cara interior

Chapa liso de acero de 0,4mm prelacada y con tratamiento antioxidación
 Acanalado fino y textura 'stucco', blanco RAL 9010

Facturación mínima: 5,5 m²



FR

Panneau sandwich

En section de 500mm ou 610mm de hauteur utile et épaisseur de 40mm
 Intérieur en polyuréthane à haute densité et dépourvu de CFC
 Emboîtement anti-pince doigt, évitant toute possibilité de coincement pendant la marche de la porte
 Plaques de renfort en acier galvanisé, inférieures et supérieures, à l'intérieur du panneau
 Joint EPDM encastré dans la partie mâle du panneau
 Forte isolation thermique et acoustique

Coté extérieur

Tôle d'acier lisse de 0,4mm pré-laqué et avec traitement antioxydant
 Texture sablé

Coté intérieur:

Tôle d'acier de 0,4mm pré-laqué et avec traitement antioxydant
 Rainuré fin et texture 'stucco', blanc RAL 9010

Minimum de facturation: 5,5 m²

EN

Sandwich panel

In sections of 500mm or 610mm height and thickness of 40mm
 Interior of high density expanded polyurethane, CFC free
 Safe-finger interlocking system preventing any trapping episodes during door's moving cycle
 EPDM rubber seal grooved into the panel's top
 Reinforced panel's structure with galvanized steel strips in top and bottom ends of the panel
 Great thermal and acustic insulation

Outer appearance:

0,4mm galvanized steel plate, pre-powdercoated and with anti-corrosion treatment
 Textured

Inner appearance:

0,4mm galvanized steel plate, pre-powdercoated and with anti-corrosion treatment
 Thin ribbed pattern and 'stucco' emboss, pre-powdercoated white RAL 9010

Minimum charge: 5,5 m²

**Painel Standard
Panel Estándar
Panneau Standard
Standard Panel**

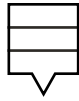

PS.040CA91	cinza	€/m ²
	gris	
	gris	
	grey	

*O painel não pode ser pintado
Panel no se puede pintar
Le panneau ne peut pas être peint
Panel can not be painted

**Painel Standard
Panel Estándar
Panneau Standard
Standard Panel**



PL.040CA91	cinza	€/m ²
	gris	
	gris	
	grey	

*O painel não pode ser pintado
Panel no se puede pintar
Le panneau ne peut pas être peint
Panel can not be painted



PT

Painel sandwich

Em secções de 500mm ou 610mm de altura útil e espessura de 40mm
Interior em poliuretano expandido de alta densidade e isento de CFC
Encaixe anti-dedo prevenindo qualquer hipótese de entalamento durante a operação do portão
Vedante em EPDM embutido no macho do painel
Chapas de reforço em aço galvanizado, inferior e superior, no interior do painel
Grande isolamento térmico e acústico

Cara exterior

Chapa de aço de 0,4mm pré-lacada e com tratamento anti-oxidação
Texturado

Cara interior

Chapa de aço de 0,4mm pré-lacada e com tratamento anti-oxidação
Canelado fino e textura 'stucco', branco RAL 9010

Faturação mínima: 5,5 m²

ES

Panel sandwich

Con secciones de 500mm o 610mm de altura útil y espesor de 40mm
Interior de poliuretano expandido de gran densidad y libre de CFC
Encaje antipinzamiento preveniendo cualquier situación de riesgo durante su movimentación
Goma de EPDM incrustada en el macho del panel
Área de refuerzo, inferior y superior, de acero galvanizado, en el interior del panel
Gran aislamiento térmico y acústico

Cara exterior

Chapa de acero liso de 0,4mm prelacada y con tratamiento antioxidación
Texturado

Cara interior

Chapa lisa de acero de 0,4mm prelacada y con tratamiento antioxidación
Acanalado fino y textura 'stucco', blanco RAL 9010

Facturación mínima: 5,5 m²



FR

Panneau sandwich

En section de 500mm ou 610mm de hauteur utile et épaisseur de 40mm
 Intérieur en polyuréthane à haute densité et dépourvu de CFC
 Emboîtement anti-pince doigt, évitant toute possibilité de coincement pendant la marche de la porte
 Plaques de renfort en acier galvanisé, inférieures et supérieures, à l'intérieur du panneau
 Joint EPDM encastré dans la partie mâle du panneau
 Forte isolation thermique et acoustique

Coté extérieur

Tôle d'acier lisse de 0,4mm pré-laqué et avec traitement antioxydant
 Texturé

Coté intérieur:

Tôle d'acier de 0,4mm pré-laqué avec traitement antioxydant
 Rainuré fin et texture 'stucco', blanc RAL 9010

Minimum de facturation: 5,5 m²

EN

Sandwich panel

In sections of 500mm or 610mm height and thickness of 40mm
 Interior of high density expanded polyurethane, CFC free
 Safe-finger interlocking system preventing any trapping episodes during door's moving cycle
 EPDM rubber seal grooved into the panel's top
 Reinforced panel's structure with galvanized steel strips in top and bottom ends of the panel
 Great thermal and acustic insulation

Outer appearance:

0,4mm galvanized steel plate, pre-powdercoated and with anti-corrosion treatment
 Textured

Inner appearance:

0,4mm galvanized steel plate, pre-powdercoated and with anti-corrosion treatment
 Thin ribbed pattern and 'stucco' emboss, pre-powdercoated white RAL 9010

Minimum charge: 5,5 m²

Painel Standard
Panel Estándar
Panneau Standard
Standard Panel

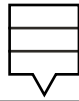

PS.040CA94

Imitação inox escovado
 Imitación de acero inoxidable cepillado
 Imitation acier inoxydable brossé
 Brushed stainless steel imitation

€/ m²

*O painel não pode ser pintado
 Panel no se puede pintar
 Le panneau ne peut pas être peint
 Panel can not be painted

Painel Standard
Panel Estándar
Panneau Standard
Standard Panel



PL.040CA94

Imitação inox escovado
 Imitación de acero inoxidable cepillado
 Imitation acier inoxydable brossé
 Brushed stainless steel imitation

€/ m²

*O painel não pode ser pintado
 Panel no se puede pintar
 Le panneau ne peut pas être peint
 Panel can not be painted



PT

Painel sandwich

Em secções de 500mm ou 610mm de altura útil e espessura de 40mm
 Interior em poliuretano expandido de alta densidade e isento de CFC
 Encaixe anti-dedo prevenindo qualquer hipótese de entalamento durante a operação do portão
 Vedante em EPDM embutido no macho do painel
 Chapas de reforço em aço galvanizado, inferior e superior, no interior do painel
 Grande isolamento térmico e acústico

Cara exterior

Chapa de aço de 0,4mm pré-lacada e com tratamento anti-oxidação
 Texturado

Cara interior

Chapa de aço de 0,4mm pré-lacada e com tratamento anti-oxidação
 Canelado fino e textura 'stucco', branco RAL 9010

Faturação mínima: 5,5 m²

ES

Panel sandwich

Con secciones de 500mm o 610mm de altura útil y espesor de 40mm
 Interior de poliuretano expandido de gran densidad y libre de CFC
 Encaje antipinzamiento preveniendo cualquier situación de riesgo durante su movimentación
 Goma de EPDM incrustada en el macho del panel
 Área de refuerzo, inferior y superior, de acero galvanizado, en el interior del panel
 Gran aislamiento térmico y acústico

Cara exterior

Chapa de acero liso de 0,4mm prelacada y con tratamiento antioxidación
 Texturado

Cara interior

Chapa liso de acero de 0,4mm prelacada y con tratamiento antioxidación
 Acanalado fino y textura 'stucco', blanco RAL 9010

Facturación mínima: 5,5 m²



FR

Panneau sandwich

En section de 500mm ou 610mm de hauteur utile et épaisseur de 40mm
 Intérieur en polyuréthane à haute densité et dépourvu de CFC
 Emboîtement anti-pince doigt, évitant toute possibilité de coincement pendant la marche de la porte
 Plaques de renfort en acier galvanisé, inférieures et supérieures, à l'intérieur du panneau
 Joint EPDM encastré dans la partie mâle du panneau
 Forte isolation thermique et acoustique

Coté extérieur

Tôle d'acier lisse de 0,4mm pré-laqué et avec traitement antioxydant
 Texturé

Coté intérieur:

Tôle d'acier de 0,4mm pré-laqué avec traitement antioxydant
 Rainuré fin et texture 'stucco', blanc RAL 9010

Minimum de facturation: 5,5 m²

EN

Sandwich panel

In sections of 500mm or 610mm height and thickness of 40mm
 Interior of high density expanded polyurethane, CFC free
 Safe-finger interlocking system preventing any trapping episodes during door's moving cycle
 EPDM rubber seal grooved into the panel's top
 Reinforced panel's structure with galvanized steel strips in top and bottom ends of the panel
 Great thermal and acustic insulation

Outer appearance:

0,4mm galvanized steel plate, pre-powdercoated and with anti-corrosion treatment
 Textured

Inner appearance:

0,4mm galvanized steel plate, pre-powdercoated and with anti-corrosion treatment
 Thin ribbed pattern and 'stucco' emboss, pre-powdercoated white RAL 9010

Minimum charge: 5,5 m²

**Painel Standard
Panel Estándar
Panneau Standard
Standard Panel**

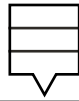

PS.040CA93

Imitação de aço corten
Imitación de acero corten
Imitation acier corten
Corten steel imitation

€/m²

*O painel não pode ser pintado
Panel no se puede pintar
Le panneau ne peut pas être peint
Panel can not be painted

**Painel Standard
Panel Estándar
Panneau Standard
Standard Panel**

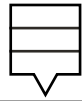

PL.040CA93

Imitação de aço corten
Imitación de acero corten
Imitation acier corten
Corten steel imitation

€/m²

*O painel não pode ser pintado
Panel no se puede pintar
Le panneau ne peut pas être peint
Panel can not be painted



PT

Painel sandwich

Em secções de 500mm ou 610mm de altura útil e espessura de 40mm
Interior em poliuretano expandido de alta densidade e isento de CFC
Encaixe anti-dedo prevenindo qualquer hipótese de entalamento durante a operação do portão
Vedante em EPDM embutido no macho do painel
Chapas de reforço em aço galvanizado, inferior e superior, no interior do painel
Grande isolamento térmico e acústico

Cara exterior

Chapa de aço de 0,4mm pré-lacada e com tratamento anti-oxidação
Texturado

Cara interior

Chapa de aço de 0,4mm pré-lacada e com tratamento anti-oxidação
Canelado fino e textura 'stucco', branco RAL 9010

Faturação mínima: 5,5 m²

ES

Panel sandwich

Con secciones de 500mm o 610mm de altura útil y espesor de 40mm
Interior de poliuretano expandido de gran densidad y libre de CFC
Encaje antipinzamiento preveniendo cualquier situación de riesgo durante su movimentación
Goma de EPDM incrustada en el macho del panel
Área de refuerzo, inferior y superior, de acero galvanizado, en el interior del panel
Gran aislamiento térmico y acústico

Cara exterior

Chapa de acero liso de 0,4mm prelacada y con tratamiento antioxidación
Texturado

Cara interior

Chapa lisa de acero de 0,4mm prelacada y con tratamiento antioxidación
Acanalado fino y textura 'stucco', blanco RAL 9010

Facturación mínima: 5,5 m²



FR

Panneau sandwich

En section de 500mm ou 610mm de hauteur utile et épaisseur de 40mm
 Intérieur en polyuréthane à haute densité et dépourvu de CFC
 Emboîtement anti-pince doigt, évitant toute possibilité de coincement pendant la marche de la porte
 Plaques de renfort en acier galvanisé, inférieures et supérieures, à l'intérieur du panneau
 Joint EPDM encastré dans la partie mâle du panneau
 Forte isolation thermique et acoustique

Coté extérieur

Tôle d'acier lisse de 0,4mm pré-laqué et avec traitement antioxydant
 Texturé

Coté intérieur:

Tôle d'acier de 0,4mm pré-laqué avec traitement antioxydant
 Rainuré fin et texture 'stucco', blanc RAL 9010

Minimum de facturation: 5,5 m²

EN

Sandwich panel

In sections of 500mm or 610mm height and thickness of 40mm
 Interior of high density expanded polyurethane, CFC free
 Safe-finger interlocking system preventing any trapping episodes during door's moving cycle
 EPDM rubber seal grooved into the panel's top
 Reinforced panel's structure with galvanized steel strips in top and bottom ends of the panel
 Great thermal and acustic insulation

Outer appearance:

0,4mm galvanized steel plate, pre-powdercoated and with anti-corrosion treatment
 Textured

Inner appearance:

0,4mm galvanized steel plate, pre-powdercoated and with anti-corrosion treatment
 Thin ribbed pattern and 'stucco' emboss, pre-powdercoated white RAL 9010

Minimum charge: 5,5 m²

LISO LISO / LISSE LISSE / SUPER FLAT

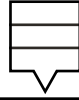
Painel Standard
Panel Estándar
Panneau Standard
Standard Panel

PS.040CA20	Branco Blanco Blanc White	RAL9010	€/ m ²
PS.040CA22	Cinza Gris Gris Grey	RAL7016	€/ m ²
PS.040CA23	Imitação de madeira clara Imitación de madera clara Imitation bois clair Light timber coated design	Uma face Una cara Une face One-side	€/ m ²
PS.040CA24	Imitação de madeira escura Imitación de madera oscura Imitation bois foncé Dark timber coated design	Uma face Una cara Une face One-side	€/ m ²
Pintura a pedido Pintura por pedido Peinture sur demande Painted on demand			
PS.040CA89	Catálogo RAL (1 face) Carta RAL (1 cara) Nuancier RAL (1 face) RAL colour chart (1 side)		€/ m ²
PS.040CA88	Afinação por amostra (1 face) Afinación por muestra (1 cara) Afination par échantillon (1 face) Sampled colour (1 side)		€/ m ²

Painel Standard
Panel Estándar
Panneau Standard
Standard Panel

PL.040CA20	Branco Blanco Blanc White	RAL9010	€/ m ²
PL.040CA22	Cinza Gris Gris Grey	RAL7016	€/ m ²
PL.040CA23	Imitação de madeira clara Imitación de madera clara Imitation bois clair Light timber coated design	Uma face Una cara Une face One-side	€/ m ²
PL.040CA24	Imitação de madeira escura Imitación de madera oscura Imitation bois foncé Dark timber coated design	Uma face Una cara Une face One-side	€/ m ²
Pintura a pedido Pintura por pedido Peinture sur demande Painted on demand			
PL.040CA89	Catálogo RAL (1 face) Carta RAL (1 cara) Nuancier RAL (1 face) RAL colour chart (1 side)		€/ m ²
PL.040CA88	Afinação por amostra (1 face) Afinación por muestra (1 cara) Afination par échantillon (1 face) Sampled colour (1 side)		€/ m ²



PT

Painel sandwich

Em secções de 500mm ou 610mm de altura útil e espessura de 40mm
Interior em poliuretano expandido de alta densidade e isento de CFC 's
Encaixe anti-dedo prevenindo qualquer hipótese de entalamento durante a operação do portão
Vedante em EPDM embutido no macho do painel
Chapas de reforço em aço galvanizado, inferior e superior, no interior do painel
Grande isolamento térmico e acústico

Cara exterior

Chapa de aço de 0,7mm pré-lacada e com tratamento anti-oxidação
Textura Lisa

Cara interior

Chapa de aço de 0,4mm pré-lacada e com tratamento anti-oxidação
Canelado fino e textura 'stucco', branco RAL 9010

Faturação mínima: 5,5 m²

ES

Panel sandwich

Con secciones de 500mm o 610mm de altura útil e espesor de 40mm
Interior de poliuretano expandido de gran densidad y libre de CFC
Encaje antipinzamiento preveniendo cualquier situación de riesgo durante su movimentación
Goma de EPDM incrustada en el macho del panel
Área de refuerzo, inferior y superior, de acero galvanizado, en el interior del panel
Gran aislamiento térmico y acústico

Cara exterior

Chapa de acero 0,7mm prelacada y con tratamiento antioxidación
Textura Lisa

Cara interior

Chapa liso de acero de 0,4mm prelacada y con tratamiento antioxidación
Acanalado fino y textura 'stucco', blanco RAL 9010

Facturación mínima: 5,5 m²



FR

Panneau sandwich

En section de 500mm ou 610mm de hauteur utile et épaisseur de 40mm
Intérieur en polyuréthane à haute densité et dépourvu de CFC
Emboîtement anti-pince doigt, évitant toute possibilité de coincement pendant la marche de la porte
Plaques de renfort en acier galvanisé, inférieures et supérieures, à l'intérieur du panneau
Joint EPDM encastré dans la partie mâle du panneau
Forte isolation thermique et acoustique

Coté extérieur

Tôle d'acier lisse de 0,7mm pré-laqué et avec traitement antioxydant
Texture lisse

Coté intérieur:

Tôle d'acier de 0,4mm pré-laqué et avec traitement antioxydant
Rainuré fin et texture 'stucco', blanc RAL 9010

Minimum de facturation: 5,5 m²

EN

Sandwich panel

In sections of 500mm or 610mm height and thickness of 40mm
Interior of high density expanded polyurethane, CFC free
Safe-finger interlocking system preventing any trapping episodes during door's moving cycle
EPDM rubber seal grooved into the panel's top
Reinforced panel's structure with galvanized steel strips in top and bottom ends of the panel
Great thermal and acustic insulation

Outer appearance:

0,7mm galvanized steel plate, pre-powdercoated and with anti-corrosion treatment
Smooth texture

Inner appearance:

0,4mm galvanized steel plate, pre-powdercoated and with anti-corrosion treatment
Thin ribbed pattern and 'stucco' emboss, pre-powdercoated white RAL 9010

Minimum charge: 5,5 m²

UNICANELADO LISO / MONO LIGNE LISSE / CENTRE RIBBED SUPER FLAT

Painel Standard
Panel Estándar
Panneau Standard
Standard Panel

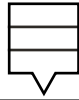

PS.040CA30	Branco Blanco Blanc White	RAL9010	€ / m ²
PS.040CA33	Imitação de madeira clara Imitación de madera clara Imitation bois clair Light timber coated design	Uma face Una cara Une face One-side	€ / m ²
PS.040CA34	Imitação de madeira escura Imitación de madera oscura Imitation bois foncé Dark timber coated design	Uma face Una cara Une face One-side	€ / m ²
PS.040CA76	Imitação de madeira clara Imitación de madera clara Imitation bois clair Light timber coated design	Duas faces Dos caras Deux faces Two-sided	€ / m ²
PS.040CA77	Imitação de madeira escura Imitación de madera oscura Imitation bois foncé Dark timber coated design	Duas faces Dos caras Deux faces Two-sided	€ / m ²

Pintura a pedido
Pintura por pedido
Peinture sur demande
Painted on demand

PS.040CA89	Catálogo RAL (1 face) Carta RAL (1 cara) Nuancier RAL (1 face) RAL colour chart (1 side)		€ / m ²
PS.040CA88	Afinação por amostra (1 face) Afinación por muestra (1 cara) Afination par échantillon (1 face) Sampled colour (1 side)		€ / m ²

Painel Standard
Panel Estándar
Panneau Standard
Standard Panel



PL.040CA30	Branco Blanco Blanc White	RAL9010	€ / m ²
PL.040CA33	Imitação de madeira clara Imitación de madera clara Imitation bois clair Light timber coated design	Uma face Una cara Une face One-side	€ / m ²
PL.040CA34	Imitação de madeira escura Imitación de madera oscura Imitation bois foncé Dark timber coated design	Uma face Una cara Une face One-side	€ / m ²
PL.040CA76	Imitação de madeira clara Imitación de madera clara Imitation bois clair Light timber coated design	Duas faces Dos caras Deux faces Two-sided	€ / m ²
PL.040CA77	Imitação de madeira escura Imitación de madera oscura Imitation bois foncé Dark timber coated design	Duas faces Dos caras Deux faces Two-sided	€ / m ²

Pintura a pedido
Pintura por pedido
Peinture sur demande
Painted on demand

PL.040CA89	Catálogo RAL (1 face) Carta RAL (1 cara) Nuancier RAL (1 face) RAL colour chart (1 side)		€ / m ²
PL.040CA88	Afinação por amostra (1 face) Afinación por muestra (1 cara) Afination par échantillon (1 face) Sampled colour (1 side)		€ / m ²



PT

Painel sandwich

Em secções de 500mm de altura útil e espessura de 40mm
Interior em poliuretano expandido de alta densidade e isento de CFC´s
Encaixe anti-dedo prevenindo qualquer hipótese de entalamento durante a operação do portão
Vedante em EPDM embutido no macho do painel
Chapas de reforço em aço galvanizado, inferior e superior, no interior do painel
Grande isolamento térmico e acústico

Cara exterior

Chapa de aço de 0,7mm pré-lacada e com tratamento anti-oxidação
Unicanl largo, textura Lisa

Cara interior

Chapa de aço de 0,4mm pré-lacada e com tratamento anti-oxidação
Canelado fino e textura 'stucco', branco RAL 9010

Faturação mínima: 5,5 m²

ES

Panel sandwich

Con secciones de 500mm de altura útil e espesor de 40mm
Interior de poliuretano expandido de gran densidad y libre de CFC
Encaje antipinzamiento preveniendo cualquier situación de riesgo durante su movimentación
Goma de EPDM incrustada en el macho del panel
Área de refuerzo, inferior y superior, de acero galvanizado, en el interior del panel
Gran aislamiento térmico y acústico

Cara exterior

Chapa de acero 0,7mm prelacada y con tratamiento antioxidación
Unicanelado largo, textura lisa

Cara interior

Chapa lisa de acero de 0,4mm prelacada y con tratamiento antioxidación
Acanalado fino y textura 'stucco', blanco RAL 9010

Facturación mínima: 5,5 m²



FR

Panneau sandwich

En section de 500mm de hauteur utile et épaisseur de 40mm
 Intérieur en polyuréthane à haute densité et dépourvu de CFC
 Emboîtement anti-pince doigt, évitant toute possibilité de coincement pendant la marche de la porte
 Plaques de renfort en acier galvanisé, inférieures et supérieures, à l'intérieur du panneau
 Joint EPDM encastré dans la partie mâle du panneau
 Forte isolation thermique et acoustique

Coté extérieur

Tôle d'acier lisse de 0,7mm pré-laqué et avec traitement antioxydant
 Mono ligne large, texture lisse

Coté intérieur:

Tôle d'acier de 0,4mm pré-laqué et avec traitement antioxydant
 Rainuré fin et texture 'stucco', blanc RAL 9010

Minimum de facturation: 5,5 m²

EN

Sandwich panel

In sections of 500mm height and thickness of 40mm
 Interior of high density expanded polyurethane, CFC free
 Safe-finger interlocking system preventing any trapping episodes during door's moving cycle
 EPDM rubber seal grooved into the panel's top
 Reinforced panel's structure with galvanized steel strips in top and bottom ends of the panel
 Great thermal and acustic insulation

Outer appearance:

0,7mm galvanized steel plate, pre-powdercoated and with anti-corrosion treatment
 Wide center ribbed, smooth texture

Inner appearance:

0,4mm galvanized steel plate, pre-powdercoated and with anti-corrosion treatment
 Thin ribbed pattern and 'stucco' emboss, pre-powdercoated white RAL 9010

Minimum charge: 5,5 m²

LM FRISO ÚNICO WOODGRAIN



UNICANELADO WOODGRAIN / MONO LIGNE WOODGRAIN / CENTRE RIBBED WOODGRAIN

Painel Standard
Panel Estándar
Panneau Standard
Standard Panel



PS.040CA40	Branco Blanco Blanc White	RAL9010	€/ m ²
PS.040CA82	Cinza Gris Gris Grey	RAL7016	€/ m ²
Pintura a pedido Pintura por pedido Peinture sur demande Painted on demand			
PS.040CA49	Catálogo RAL (1 face) Carta RAL (1 cara) Nuancier RAL (1 face) RAL colour chart (1 side)		€/ m ²
PS.040CA48	Afinação por amostra (1 face) Afinación por muestra (1 cara) Afination par échantillon (1 face) Sampled colour (1 side)		€/ m ²

Painel Standard
Panel Estándar
Panneau Standard
Standard Panel



PL.040CA40	Branco Blanco Blanc White	RAL9010	€/ m ²
PL.040CA82	Cinza Gris Gris Grey	RAL7016	€/ m ²
Pintura a pedido Pintura por pedido Peinture sur demande Painted on demand			
PL.040CA49	Catálogo RAL (1 face) Carta RAL (1 cara) Nuancier RAL (1 face) RAL colour chart (1 side)		€/ m ²
PL.040CA48	Afinação por amostra (1 face) Afinación por muestra (1 cara) Afination par échantillon (1 face) Sampled colour (1 side)		€/ m ²



PT

Painel sandwich

Em secções de 500mm de altura útil e espessura de 40mm
Interior em poliuretano expandido de alta densidade e isento de CFC´s
Encaixe anti-dedo prevenindo qualquer hipótese de entalamento durante a operação do portão
Vedante em EPDM embutido no macho do painel
Chapas de reforço em aço galvanizado, inferior e superior, no interior do painel
Grande isolamento térmico e acústico

Cara exterior

Chapa de aço de 0,4mm pré-lacada com tratamento anti-oxidação
Unicanelado largo, textura woodgrain

Cara interior

Chapa de aço de 0,4mm pré-lacada com tratamento anti-oxidação
Canelado fino e textura 'stucco', branco RAL 9010

Faturação mínima: 5,5 m²

ES

Panel sandwich

Con secciones de 500mm de altura útil y espesor de 40mm
Interior de poliuretano expandido de gran densidad y libre de CFC
Encaje antipinzamiento preveniendo cualquier situación de riesgo durante su movimentación
Goma de EPDM incrustada en el macho del panel
Área de refuerzo, inferior y superior, de acero galvanizado, en el interior del panel
Gran aislamiento térmico y acústico

Cara exterior

Chapa de acero 0,7mm prelacada con tratamiento antioxidación
Unicanelado largo, textura woodgrain

Cara interior

Chapa lisa de acero de 0,4mm prelacada con tratamiento antioxidación
Acanalado fino y textura 'stucco', blanco RAL 9010

Facturación mínima: 5,5 m²



FR

Panneau sandwich

En section de 500mm de hauteur utile et épaisseur de 40mm
 Intérieur en polyuréthane à haute densité et dépourvu de CFC
 Emboîtement anti-pince doigt, évitant toute possibilité de coincement pendant la marche de la porte
 Plaques de renfort en acier galvanisé, inférieures et supérieures, à l'intérieur du panneau
 Joint EPDM encastré dans la partie mâle du panneau
 Forte isolation thermique et acoustique

Coté extérieur

Tôle d'acier lisse de 0,4mm pré-laqué avec traitement antioxydant
 Mono ligne large, texture woodgrain

Coté intérieur:

Tôle d'acier de 0,4mm pré-laqué avec traitement antioxydant
 Rainuré fin et texture 'stucco', blanc RAL 9010

Minimum de facturation: 5,5 m²

EN

Sandwich panel

In sections of 500mm height and thickness of 40mm
 Interior of high density expanded polyurethane, CFC free
 Safe-finger interlocking system preventing any trapping episodes during door's moving cycle
 EPDM rubber seal grooved into the panel's top
 Reinforced panel's structure with galvanized steel strips in top and bottom ends of the panel
 Great thermal and acustic insulation

Outer appearance:

0,4mm galvanized steel plate, pre-powdercoated with anti-corrosion treatment
 Wide center ribbed, woodgrain

Inner appearance:

0,4mm galvanized steel plate, pre-powdercoated and with anti-corrosion treatment
 Thin ribbed pattern and 'stucco' emboss, pre-powdercoated white RAL 9010

Minimum charge: 5,5 m²

LM CANELADO LISO



ACANELADO LISO / RAINURÉ LISSE / RIBBED SUPER FLAT

Aço galvanizado / Pré - lacado
Acero galvanizado / Prelacado
Acier galvanisé / Pré-laqué
Galvanized steel / Precoated

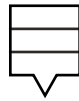

PS.040CA13	Imitação de madeira clara Imitación de madera clara Imitation bois clair Light timber coated design	Uma face Una cara Une face One-side	€/ m ²
PS.040CA14	Imitação de madeira escura Imitación de madera oscura Imitation bois foncé Dark timber coated design	Uma face Una cara Une face One-side	€/ m ²
PS.040CA73	Imitação de madeira clara Imitación de madera clara Imitation bois clair Light timber coated design	Duas faces Dos caras Deux faces Two-sided	€/ m ²
PS.040CA74	Imitação de madeira escura Imitación de madera oscura Imitation bois foncé Dark timber coated design	Duas faces Dos caras Deux faces Two-sided	€/ m ²

Aço galvanizado / Pré - lacado
Acero galvanizado / Prelacado
Acier galvanisé / Pré-laqué
Galvanized steel / Precoated



PL.040CA13	Imitação de madeira clara Imitación de madera clara Imitation bois clair Light timber coated design	Uma face Una cara Une face One-side	€/ m ²
PL.040CA14	Imitação de madeira escura Imitación de madera oscura Imitation bois foncé Dark timber coated design	Uma face Una cara Une face One-side	€/ m ²
PL.040CA73	Imitação de madeira clara Imitación de madera clara Imitation bois clair Light timber coated design	Duas faces Dos caras Deux faces Two-sided	€/ m ²
PL.040CA74	Imitação de madeira escura Imitación de madera oscura Imitation bois foncé Dark timber coated design	Duas faces Dos caras Deux faces Two-sided	€/ m ²



PT

Painel sandwich

Em secções de 500mm ou 610mm de altura útil e espessura de 40mm
Interior em poliuretano expandido de alta densidade e isento de CFC 's
Encaixe anti-dedo prevenindo qualquer hipótese de entalamento durante a operação do portão
Vedante em EPDM embutido no macho do painel
Chapas de reforço em aço galvanizado, inferior e superior, no interior do painel
Grande isolamento térmico e acústico

Cara exterior

Chapa de aço de 0,4mm pré-lacada com tratamento anti-oxidação
Canelado fino, textura Lisa

Cara interior

Chapa de aço de 0,4mm pré-lacada com tratamento anti-oxidação
Uma face: Canelado fino e textura 'stucco', branco RAL 9010
Duas faces: Canelado fino, textura Lisa

Faturação mínima: 5,5 m²

ES

Panel sandwich

Con secciones de 500mm o 610mm de altura útil y espesor de 40mm
Interior de poliuretano expandido de gran densidad y libre de CFC
Encaje antipinzamiento preveniendo cualquier situación de riesgo durante su movimentación
Goma de EPDM incrustada en el macho del panel
Área de refuerzo, inferior y superior, de acero galvanizado, en el interior del panel
Gran aislamiento térmico y acústico

Cara exterior

Chapa de acero 0,4mm prelacada con tratamiento antioxidación
Acanalado fino, textura Lisa

Cara interior

Chapa liso acero de 0,4mm prelacada con tratamiento antioxidación
Una cara: Acanalado fino y textura 'stucco', blanco RAL 9010
Dos caras: Acanalado fino, textura Lisa

Facturación mínima: 5,5 m²



FR

Panneau sandwich

En section de 500mm ou 610mm de hauteur utile et épaisseur de 40mm
 Intérieur en polyuréthane à haute densité et dépourvu de CFC
 Emboîtement anti-pince doigt, évitant toute possibilité de coincement pendant la marche de la porte
 Plaques de renfort en acier galvanisé, inférieures et supérieures, à l'intérieur du panneau
 Joint EPDM encastré dans la partie mâle du panneau
 Forte isolation thermique et acoustique

Coté extérieur

Tôle d'acier lisse de 0,4mm pré-laqué et avec traitement antioxydant
 Rainuré fin, texture lisse

Coté intérieur:

Tôle d'acier de 0,4mm pré-laqué et avec traitement antioxydant
 Une face: Rainuré fin et texture 'stucco', blanc RAL 9010
 Deux faces: Rainuré fin, texture lisse

Minimum de facturation: 5,5 m²

EN

Sandwich panel

In sections of 500mm or 610mm height and thickness of 40mm
 Interior of high density expanded polyurethane, CFC free
 Safe-finger interlocking system preventing any trapping episodes during door's moving cycle
 EPDM rubber seal grooved into the panel's top
 Reinforced panel's structure with galvanized steel strips in top and bottom ends of the panel
 Great thermal and acustic insulation

Outer appearance:

0,4mm galvanized steel plate, pre-powdercoated and with anti-corrosion treatment
 Thin ribbed, smooth texture

Inner appearance:

0,4mm galvanized steel plate, pre-powdercoated and with anti-corrosion treatment
 One-side: Thin ribbed pattern and 'stucco' emboss, pre-powdercoated white RAL 9010
 Two-sided: Thin ribbed, smooth texture

Minimum charge: 5,5 m²

ACANELADO WOODGRAIN / RAINURÉ WOODGRAIN / RIBBED WOODGRAIN

Aço galvanizado / Pré - lacado
Acero galvanizado / Prelacado
Acier galvanisé / Pré-laqué
Galvanized steel / Precoated



PS.040CA00	Branco Blanco Blanc White	RAL 9010	€ / m ²
PS.040CA06	Creme Crema Beige Cream	RAL 1015	€ / m ²
PS.040CA07 PS.040CA15 PS.040CA11 PS.040CA12	Cinza Gris Gris Grey	RAL 9006 RAL 9007 RAL 7011 RAL 7016	€ / m ²
PS.040CA01 PS.040CA10	Verde Verde Vert Green	RAL 6005 RAL 6009	€ / m ²
PS.040CA02	Castanho Marrón Marron Brown	RAL 8014	€ / m ²
PS.040CA08	Azul Azul Bleu Blue	RAL 5010	€ / m ²
PS.040CA09	Vermelho Rojo Rouge Red	RAL 3000	€ / m ²
PS040CA18	Preto Negro Noir Black	RAL 9005	€ / m ²
Pintura a pedido Pintura por pedido Peinture sur demande Painted on demand			
PS.040CA99	Catálogo RAL (1 face) Carta RAL (1 cara) Nuancier RAL (1 face) RAL colour chart (1 side)		€ / m ²
PS.040CA98	Afinação por amostra (1 face) Afinación por muestra (1 cara) Afination par échantillon (1 face) Sampled colour (1 side)		€ / m ²

Aço galvanizado / Pré - lacado
Acero galvanizado / Prelacado
Acier galvanisé / Pré-laqué
Galvanized steel / Precoated



PL.040CA00	Branco Blanco Blanc White	RAL 9010	€ / m ²
PL.040CA06	Creme Crema Beige Cream	RAL 1015	€ / m ²
PL.040CA07 PL.040CA15 PL.040CA11 PL.040CA12	Cinza Gris Gris Grey	RAL 9006 RAL 9007 RAL 7011 RAL 7016	€ / m ²
PL.040CA01 PL.040CA10	Verde Verde Vert Green	RAL 6005 RAL 6009	€ / m ²
PL.040CA02	Castanho Marrón Marron Brown	RAL 8014	€ / m ²
PL.040CA08	Azul Azul Bleu Blue	RAL 5010	€ / m ²
PL.040CA09	Vermelho Rojo Rouge Red	RAL 3000	€ / m ²
PL040CA18	Preto Negro Noir Black	RAL 9005	€ / m ²
Aço galvanizado / Pintura a pedido Acero galvanizado / Pintura por pedido Acier galvanisé / Peinture sur demande Galvanized steel / Painted on demand			
PS.040CA99	Catálogo RAL (1 face) Carta RAL (1 cara) Nuancier RAL (1 face) RAL colour chart (1 side)		€ / m ²
PS.040CA98	Afinação por amostra (1 face) Afinación por muestra (1 cara) Afination par échantillon (1 face) Sampled colour (1 side)		€ / m ²

PT

Painel sandwich

Em secções de 500mm ou 610mm de altura útil e espessura de 40mm
Interior em poliuretano expandido de alta densidade e isento de CFC´s
Encaixe anti-dedo prevenindo qualquer hipótese de entalamento durante a operação do portão
Vedante em EPDM embutido no macho do painel
Chapas de reforço em aço galvanizado, inferior e superior, no interior do painel
Grande isolamento térmico e acústico

Cara exterior

Chapa de aço de 0,4mm pré-lacada e com tratamento anti-oxidação
Textura woodgrain

Cara interior

Chapa de aço de 0,4mm pré-lacada com tratamento anti-oxidação
Canelado fino e textura 'stucco', branco RAL 9010

Faturação mínima: 5,5 m²

ES

Panel sandwich

Con secciones de 500mm o 610mm de altura útil y espesor de 40mm
Interior de poliuretano expandido de gran densidad y libre de CFC
Encaje antipinzamiento preveniendo cualquier situación de riesgo durante su movimentación
Goma de EPDM incrustada en el macho del panel
Área de refuerzo, inferior y superior, de acero galvanizado, en el interior del panel
Gran aislamiento térmico y acústico

Cara exterior

Chapa de acero 0,4mm prelacada con tratamiento antioxidación
Textura woodgrain

Cara interior

Chapa de acero de 0,4mm prelacada con tratamiento antioxidación
Acanalado fino y textura 'stucco', blanco RAL 9010

Facturación mínima: 5,5 m²



FR

Panneau sandwich

En section de 500mm ou 610mm de hauteur utile et épaisseur de 40mm
 Intérieur en polyuréthane à haute densité et dépourvu de CFC
 Emboîtement anti-pince doigt, évitant toute possibilité de coincement pendant la marche de la porte
 Plaques de renfort en acier galvanisé, inférieures et supérieures, à l'intérieur du panneau
 Joint EPDM encastré dans la partie mâle du panneau
 Forte isolation thermique et acoustique

Coté extérieur

Tôle d'acier lisse de 0,4mm pré-laqué et avec traitement antioxydant
 Texture woodgrain

Coté intérieur:

Tôle d'acier de 0,4mm pré-laqué et avec traitement antioxydant
 Rainuré fin et texture 'stucco', blanc RAL 9010

Minimum de facturation: 5,5 m²

EN

Sandwich panel

In sections of 500mm or 610mm height and thickness of 40mm
 Interior of high density expanded polyurethane, CFC free
 Safe-finger interlocking system preventing any trapping episodes during door's moving cycle
 EPDM rubber seal grooved into the panel's top
 Reinforced panel's structure with galvanized steel strips in top and bottom ends of the panel
 Great thermal and acustic insulation

Outer appearance:

0,4mm galvanized steel plate, pre-powdercoated and with anti-corrosion treatment
 Woodgrain texture

Inner appearance:

0,4mm galvanized steel plate, pre-powdercoated and with anti-corrosion treatment
 Thin ribbed pattern and 'stucco' emboss, pre-powdercoated white RAL 9010

Minimum charge: 5,5 m²

MICROACANALADO / MICRONERVURÉ / MICRO RIBBED

Painel Standard
Panel Estándar
Panneau Standard
Standard Panel



PS.040MA00	Branco Blanco Blanc White	RAL 9010	€/ m ²
-------------------	------------------------------------	----------	-------------------

Pintura a pedido
Pintura por pedido
Peinture sur demande
Painted on demand

PS.040MA99	Catálogo RAL (1 face) Carta RAL (1 cara) Nuancier RAL (1 face) RAL colour chart (1 side)		€/ m ²
-------------------	---------------------------------------------------------------------------------------------------	--	-------------------

PS.040MA98	Afinação por amostra (1 face) Afinación por muestra (1 cara) Afination par échantillon (1 face) Sampled colour (1 side)		€/ m ²
-------------------	----------------------------------------------------------------------------------------------------------------------------------	--	-------------------

Painel Standard
Panel Estándar
Panneau Standard
Standard Panel

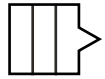

PS.040MA00	Branco Blanco Blanc White	RAL 9010	€/ m ²
-------------------	------------------------------------	----------	-------------------

Pintura a pedido
Pintura por pedido
Peinture sur demande
Painted on demand

PL.040MA99	Catálogo RAL (1 face) Carta RAL (1 cara) Nuancier RAL (1 face) RAL colour chart (1 side)		€/ m ²
-------------------	---------------------------------------------------------------------------------------------------	--	-------------------

PL.040MA98	Afinação por amostra (1 face) Afinación por muestra (1 cara) Afination par échantillon (1 face) Sampled colour (1 side)		€/ m ²
-------------------	----------------------------------------------------------------------------------------------------------------------------------	--	-------------------



PT

Painel sandwich

Em secções de 500mm ou 610mm de altura útil e espessura de 40mm
Interior em poliuretano expandido de alta densidade e isento de CFC´s
Encaixe anti-dedo prevenindo qualquer hipótese de entalamento durante a operação do portão
Vedante em EPDM embutido no macho do painel
Chapas de reforço em aço galvanizado, inferior e superior, no interior do painel
Grande isolamento térmico e acústico

Cara exterior

Chapa de aço de 0,4mm pré-lacada com tratamento anti-oxidação
Micro friso, textura Lisa

Cara interior

Chapa de aço de 0,4mm pré-lacada com tratamento anti-oxidação
Canelado fino e textura 'stucco', branco RAL 9010

Faturação mínima: 5,5 m²

ES

Panel sandwich

Con secciones de 500mm o 610mm de altura útil y espesor de 40mm
Interior de poliuretano expandido de gran densidad y libre de CFC
Encaje antipinzamiento preveniendo cualquier situación de riesgo durante su movimentación
Goma de EPDM incrustada en el macho del panel
Área de refuerzo, inferior y superior, de acero galvanizado, en el interior del panel
Gran aislamiento térmico y acústico

Cara exterior

Chapa de acero 0,4mm prelacada con tratamiento antioxidación
Micro acanelado, textura lisa

Cara interior

Chapa lisa de acero de 0,4mm prelacada con tratamiento antioxidación
Acanalado fino y textura 'stucco', blanco RAL 9010

Faturação mínima: 5,5 m²



FR

Panneau sandwich

En section de 500mm ou 610mm de hauteur utile et épaisseur de 40mm
Intérieur en polyuréthane à haute densité et dépourvu de CFC
Emboîtement anti-pince doigt, évitant toute possibilité de coincement pendant la marche de la porte
Plaques de renfort en acier galvanisé, inférieures et supérieures, à l'intérieur du panneau
Joint EPDM encastré dans la partie mâle du panneau
Forte isolation thermique et acoustique

Coté extérieur

Tôle d'acier lisse de 0,4mm pré-laqué et avec traitement antioxydant
Micronervuré, texture lisse

Coté intérieur:

Tôle d'acier de 0,4mm pré-laqué et avec traitement antioxydant
Rainuré fin et texture 'stucco', blanc RAL 9010

Faturação mínima: 5,5 m²

EN

Sandwich panel

In sections of 500mm or 610mm height and thickness of 40mm
Interior of high density expanded polyurethane, CFC free
Safe-finger interlocking system preventing any trapping episodes during door's moving cycle
EPDM rubber seal grooved into the panel's top
Reinforced panel's structure with galvanized steel strips in top and bottom ends of the panel
Great thermal and acustic insulation

Outer appearance:

0,4mm galvanized steel plate, pre-powdercoated and with anti-corrosion treatment
Micro ribbed, smooth texture

Inner appearance:

0,4mm galvanized steel plate, pre-powdercoated and with anti-corrosion treatment
Thin ribbed pattern and 'stucco' emboss, pre-powdercoated white RAL 9010

Faturação mínima: 5,5 m²

Painel Standard
Panel Estándar
Panneau Standard
Standard Panel

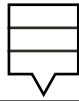

PS.040AA00	Branco Blanco Blanc White	RAL9010	€/m ²
-------------------	------------------------------------	---------	------------------

Pintura a pedido
Pintura por pedido
Peinture sur demande
Painted on demand

PS.040AA99	Catálogo RAL (1 face) Carta RAL (1 cara) Nuancier RAL (1 face) RAL colour chart (1 side)		€/m ²
-------------------	---------------------------------------------------------------------------------------------------	--	------------------

PS.040AA98	Afinação por amostra (1 face) Afinación por muestra (1 cara) Afination par échantillon (1 face) Sampled colour (1 side)		€/m ²
-------------------	----------------------------------------------------------------------------------------------------------------------------------	--	------------------

Painel Standard
Panel Estándar
Panneau Standard
Standard Panel



PL.040AA00	Branco Blanco Blanc White	RAL9010	€/m ²
-------------------	------------------------------------	---------	------------------

Pintura a pedido
Pintura por pedido
Peinture sur demande
Painted on demand

PL.040CA49	Catálogo RAL (1 face) Carta RAL (1 cara) Nuancier RAL (1 face) RAL colour chart (1 side)		€/m ²
-------------------	---------------------------------------------------------------------------------------------------	--	------------------

PL.040CA48	Afinação por amostra (1 face) Afinación por muestra (1 cara) Afination par échantillon (1 face) Sampled colour (1 side)		€/m ²
-------------------	----------------------------------------------------------------------------------------------------------------------------------	--	------------------

Medidas p/ Faturação**Medidas p/ Faturación****Dimensions p/ Facturation****Billing Dimension****Número de Almofadas****Número de Cuarterones****Numéro de Cassettes****Number of Panels****Espaço entre Almofadas****Espaciamento Cuarterones****Espacement des Cassettes****Interpanel Space****Tamanho Mínimo (Painel)****Tamaño Mínimo (panel)****Taille Minimum (panneau)****Minimum Size (panel)****Tamanho Máximo (painel)****Tamaño Máximo (panel)****Taille Maximale (panneau)****Maximum Size (panel)**

	2450	2750	3050	3350	3650	4050	4350	4850	5150	5250	5950	6750	7400	7600	8100	8400
	3	3	4	4	5	5	5	6	6	7	7	8	10	9	11	10
	210	300	210	210	210	210	300	210	300	210	300	300	210	300	210	300
	2001	2181	2718	2718	3435	3435	3795	4152	4602	4869	5409	6216	7020	7023	7737	7830
	2410	2710	3010	3310	3610	4010	4310	4810	5102	5189	5909	6716	7340	7523	8000	8000

PT**Painel sandwich**

Em secções de 500mm ou 610mm de altura útil e espessura de 40mm

Interior em poliuretano expandido de alta densidade e isento de CFC

Encaixe anti-dedo prevenindo qualquer hipótese de entalamento durante a operação do portão

Vedante em EPDM embutido no macho do painel

Chapas de reforço em aço galvanizado, inferior e superior, no interior do painel

Grande isolamento térmico e acústico

Cara exterior

Chapa de aço de 0,4mm pré-lacada com tratamento anti-oxidação

Almofadado e textura woodgrain

Cara interior

Chapa de aço de 0,4mm pré-lacada com tratamento anti-oxidação

Canelado fino e textura 'stucco', branco RAL 9010

Faturação mínima: 5,5 m²

ES**Panel sandwich**

Con secciones de 500mm o 610mm de altura útil y espesor de 40mm

Interior de poliuretano expandido de gran densidad y libre de CFC

Encaje antipinzamiento preveniendo cualquier situación de riesgo durante su movimentación

Goma de EPDM incrustada en el macho del panel

Área de refuerzo, inferior y superior, de acero galvanizado, en el interior del panel

Gran aislamiento térmico y acústico

Cara exterior

Chapa de acero 0,4mm prelacada y con tratamiento antioxidación

Cuarterones y textura woodgrain

Cara interior

Chapa lisa de acero de 0,4mm prelacada con tratamiento antioxidación

Acanalado fino y textura 'stucco', blanco RAL 9010

Facturación mínima: 5,5 m²



FR

Panneau sandwich

En section de 500mm ou 610mm de hauteur utile et épaisseur de 40mm
 Intérieur en polyuréthane à haute densité et dépourvu de CFC
 Emboîtement anti-pince doigt, évitant toute possibilité de coincement pendant la marche de la porte
 Plaques de renfort en acier galvanisé, inférieures et supérieures, à l'intérieur du panneau
 Joint EPDM encastré dans la partie mâle du panneau
 Forte isolation thermique et acoustique

Coté extérieur

Tôle d'acier de 0,4mm pré-laqué et avec traitement antioxydant
 Casette et texture woodgrain

Coté intérieur:

Tôle d'acier de 0,4mm pré-laqué et avec traitement antioxydant
 Rainuré fin et texture 'stucco', blanc RAL 9010

Minimum de facturation: 5,5 m²

EN

Sandwich panel

In sections of 500mm or 610mm height and thickness of 40mm
 Interior of high density expanded polyurethane, CFC free
 Safe-finger interlocking system preventing any trapping episodes during door's moving cycle
 EPDM rubber seal grooved into the panel's top
 Reenforced panel's structure with galvanized steel strips in top and bottom ends of the panel
 Great thermal and acustic insulation

Outer appearance:

0,4mm galvanized steel plate, pre-powdercoated and with anti-corrosion treatment
 Panelled and woodgrain texture

Inner appearance:

0,4mm galvanized steel plate, pre-powdercoated and with anti-corrosion treatment
 Thin ribbed pattern and 'stucco' emboss, pre-powdercoated white RAL 9010

Minimum charge: 5,5 m²

Alumínio, pré-lacado
Aluminio, prelacado
Aluminium, pré-laqué
Aluminium, precoated

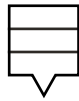

PS.040CAA2	Branco Blanco Blanc White	RAL 9030	€/m ²
-------------------	------------------------------------	----------	------------------

Alumínio, pintura a pedido
Aluminio, pintura por pedido
Aluminium, peinture sur demande
Aluminium, painted on demand

PS.040CAA5	Catálogo RAL (1 face) Carta RAL (1 cara) Nuancier RAL (1 face) RAL colour chart (1 side)		€/m ²
-------------------	---------------------------------------------------------------------------------------------------	--	------------------

PS.040CAA4	Afinação por amostra (1 face) Afinación por muestra (1 cara) Afination par échantillon (1 face) Sampled colour (1 side)		€/m ²
-------------------	----------------------------------------------------------------------------------------------------------------------------------	--	------------------

Alumínio, pré-lacado
Aluminio, prelacado
Aluminium, pré-laqué
Aluminium, precoated



PL.040CAA2	Branco Blanco Blanc White	RAL 9030	€/m ²
-------------------	------------------------------------	----------	------------------

Alumínio, pintura a pedido
Aluminio, pintura por pedido
Aluminium, peinture sur demande
Aluminium, painted on demand

PL.040CAA5	Catálogo RAL (1 face) Carta RAL (1 cara) Nuancier RAL (1 face) RAL colour chart (1 side)		€/m ²
-------------------	---------------------------------------------------------------------------------------------------	--	------------------

PL.040CAA4	Afinação por amostra (1 face) Afinación por muestra (1 cara) Afination par échantillon (1 face) Sampled colour (1 side)		€/m ²
-------------------	----------------------------------------------------------------------------------------------------------------------------------	--	------------------



PT

Painel sandwich

Em secções de 500mm ou 610mm de altura útil e espessura de 40mm
 Interior em poliuretano expandido de alta densidade e isento de CFC
 Encaixe anti-dedo prevenindo qualquer hipótese de entalamento durante a operação do portão
 Vedante em EPDM embutido no macho do painel
 Chapas de reforço em aço galvanizado, inferior e superior, no interior do painel
 Grande isolamento térmico e acústico

Cara exterior

Chapa de alumínio de 0,6mm pré-lacada com tratamento anti-oxidação
 Textura woodgrain

Cara interior

Chapa de alumínio de 0,6mm pré-lacada com tratamento anti-oxidação
 Canelado fino e textura 'stucco', branco RAL 9030

Faturação mínima: 5,5 m²

ES

Panel sandwich

Con secciones de 500 o 610mm de altura útil e espesor de 40mm
 Interior de poliuretano expandido de gran densidad y libre de CFC
 Encaje antipinzamiento preveniendo cualquier situación de riesgo durante su movimentación
 Goma de EPDM incrustada en el macho del panel
 Área de refuerzo, inferior y superior, de acero galvanizado, en el interior del panel
 Gran aislamiento térmico y acústico

Cara exterior

Chapa de aluminio de 0,6mm prelacada con tratamiento antioxidación
 Textura woodgrain

Cara interior

Chapa de aluminio de 0,6mm prelacada con tratamiento antioxidación
 Acanalado fino y textura 'stucco', blanco RAL 9030

Facturación mínima: 5,5 m²



FR

Panneau sandwich

En section de 500 ou 610mm de hauteur utile et épaisseur de 40mm
 Intérieur en polyuréthane à haute densité et dépourvu de CFC
 Emboîtement anti-pince doigt, évitant toute possibilité de coincement pendant la marche de la porte
 Plaques de renfort en acier galvanisé, inférieures et supérieures, à l'intérieur du panneau
 Joint EPDM encastré dans la partie mâle du panneau
 Forte isolation thermique et acoustique

Coté extérieur

Tôle d'aluminium lisse de 0,6mm pré-laqué et avec traitement antioxydant

Texture woodgrain

Coté intérieur:
 Tôle d'aluminium de 0,6mm pré-laqué et avec traitement antioxydant
 Rainuré fin et texture 'stucco', blanc RAL 9030

Minimum de facturation: 5,5 m²

EN

Sandwich panel

In sections of 500 or 610mm height and thickness of 40mm
 Interior of high density expanded polyurethane, CFC free
 Safe-finger interlocking system preventing any trapping episodes during door's moving cycle
 EPDM rubber seal grooved into the panel's top
 Reenforced panel's structure with galvanized steel strips in top and bottom ends of the panel
 Great thermal and acustic insulation

Outer appearance

0,6mm aluminium plate, pre-powdercoated and with anti-corrosion treatment
 Woodgrain texture

Inner appearance

0,6mm aluminium plate, pre-powdercoated and with anti-corrosion treatment
 Thin ribbed pattern and 'stucco' emboss, pre-powdercoated white RAL 9030

Minimum charge: 5,5 m²

LM CANELADO ALUMÍNIO



LM ACANALADO ALUMINIO / LM RAINURÉ ALUMINIUM / LM RIBBED ALUMINIUM

Alumínio, pré-lacado
Aluminio, prelacado
Aluminium, pré-laqué
Aluminium, precoated



PS.040CAA0	Branco Blanco Blanc White	RAL 9030	€/m ²
-------------------	------------------------------------	----------	------------------

Alumínio, pintura a pedido
Aluminio, pintura por pedido
Aluminium, peinture sur demande
Aluminium, painted on demand

PS.040CAA9	Catálogo RAL (1 face) Carta RAL (1 cara) Nuancier RAL (1 face) RAL colour chart (1 side)		€/m ²
-------------------	---------------------------------------------------------------------------------------------------	--	------------------

PS.040CAA8	Afinação por amostra (1 face) Afinación por muestra (1 cara) Afination par échantillon (1 face) Sampled colour (1 side)		€/m ²
-------------------	----------------------------------------------------------------------------------------------------------------------------------	--	------------------

Alumínio, pré-lacado
Aluminio, prelacado
Aluminium, pré-laqué
Aluminium, precoated



PL.040CAA0	Branco Blanco Blanc White	RAL 9030	€/m ²
-------------------	------------------------------------	----------	------------------

Alumínio, pintura a pedido
Aluminio, pintura por pedido
Aluminium, peinture sur demande
Aluminium, painted on demand

PL.040CAA9	Catálogo RAL (1 face) Carta RAL (1 cara) Nuancier RAL (1 face) RAL colour chart (1 side)		€/m ²
-------------------	---------------------------------------------------------------------------------------------------	--	------------------

PL.040CAA8	Afinação por amostra (1 face) Afinación por muestra (1 cara) Afination par échantillon (1 face) Sampled colour (1 side)		€/m ²
-------------------	----------------------------------------------------------------------------------------------------------------------------------	--	------------------



PT

Panel sandwich

Em secções de 500mm ou 610mm de altura útil e espessura de 40mm
 Interior em poliuretano expandido de alta densidade e isento de CFC
 Encaixe anti-dedo prevenindo qualquer hipótese de entalamento durante a operação do portão
 Vedante em EPDM embutido no macho do painel
 Chapas de reforço em aço galvanizado, inferior e superior, no interior do painel
 Grande isolamento térmico e acústico

Cara exterior

Chapa de alumínio de 0,6mm pré-lacada e com tratamento anti-oxidação
 Canelado largo e textura 'stucco'

Cara interior

Chapa de alumínio de 0,6mm pré-lacada e com tratamento anti-oxidação
 Canelado fino e textura 'stucco', branco RAL 9030

Faturação mínima: 5,5 m²

ES

Panel sandwich

Con secciones de 500 o 610mm de altura útil y espesor de 40mm
 Interior de poliuretano expandido de gran densidad y libre de CFC
 Encaje antipinzamiento preveniendo cualquier situación de riesgo durante su movimentación
 Goma de EPDM incrustada en el macho del panel
 Área de refuerzo, inferior y superior, de acero galvanizado, en el interior del panel
 Gran aislamiento térmico y acústico

Cara exterior

Chapa de aluminio de 0,6mm prelacada con tratamiento antioxidación
 Acanalado largo y textura 'stucco'

Cara interior

Chapa de aluminio de 0,6mm prelacada con tratamiento antioxidación
 Acanalado fino y textura 'stucco', blanco RAL 9030

Facturación mínima: 5,5 m²



FR

Panneau sandwich

En section de 500 ou 610mm de hauteur utile et épaisseur de 40mm
 Intérieur en polyuréthane à haute densité et dépourvu de CFC
 Emboîtement anti-pince doigt, évitant toute possibilité de coincement pendant la marche de la porte
 Plaques de renfort en acier galvanisé, inférieures et supérieures, à l'intérieur du panneau
 Joint EPDM encastré dans la partie mâle du panneau
 Forte isolation thermique et acoustique

Coté extérieur

Tôle d'aluminium lisse de 0,6mm pré-laqué avec traitement antioxydant
 Rainuré large et texture 'stucco'

Coté intérieur

Tôle d'aluminium de 0,6mm pré-laqué avec traitement antioxydant
 Rainuré fin et texture 'stucco', blanc RAL 9030

Minimum de facturation: 5,5 m²

EN

Sandwich panel

In sections of 500 or 610mm height and thickness of 40mm
 Interior of high density expanded polyurethane, CFC free
 Safe-finger interlocking system preventing any trapping episodes during door's moving cycle
 EPDM rubber seal grooved into the panel's top
 Reenforced panel's structure with galvanized steel strips in top and bottom ends of the panel
 Great thermal and acustic insulation

Outer appearance

0,6mm aluminium plate, pre-powdercoated with anti-corrosion treatment
 Wide ribbed pattern and 'stucco' emboss

Inner appearance

0,6mm aluminium plate, pre-powdercoated with anti-corrosion treatment
 Thin ribbed pattern and 'stucco' emboss, pre-powdercoated white RAL 9030

Minimum charge: 5,5 m²

Painel Standard, alumínio bruto
Panel Estándar, aluminio bruto
Panneau Standard, aluminium brut
Standard Panel, plain aluminium



PSLMALU	Alumínio, acrílico simples transparente Aluminio, acrílico simple transparente Aluminium, plexiglas simple transparent Aluminium, single glazed acrylic, transparent	€/ m ²
----------------	-------------------------------------------------------------------------------------------------------------------------------------------------------------------------------	-------------------

Opção, Acabamento lacado
Opción, Acabado lacado
Option, Finition laquée
Option, Powdercoated finishing

NS.TLACA2	Duas faces (m ²) Dos caras (m ²) Deux faces (m ²) Both sides (sqm)	€/ m ²
------------------	-----------------------------------------------------------------------------------------------------------------	-------------------

Porta-homem LM Alu, incluída no portão
Puerta peatonal LM Alu, suministrada con el portón
Portillon LM Alu, inclus dans la porte
Wicket door LM Alu, included in the gate

PS.900011	Alumínio, acrílico simples transparente Aluminio, acrílico simple transparente Aluminium, plexiglas simple transparent Aluminium, single glazed acrylic, transparent	€/ m ²
------------------	-------------------------------------------------------------------------------------------------------------------------------------------------------------------------------	-------------------

Acréscimo, Opção acrílico
Adición, Opción acrílico
Ajout, Option plexiglas
Addition, Option acrylic



NS.ALUT1750PDC	Acrílico duplo, transparente Acrílico doble, transparente Plexiglas double, transparent Double glazed acrylic, transparent	3+10+3	€/ m ² *
-----------------------	-------------------------------------------------------------------------------------------------------------------------------------	--------	---------------------

NS.ALUT1750PFS	Acrílico simples, fosco Acrílico simple, opaco Plexiglas simple, dépoli Single glazed acrylic, frosted	3,0 (mm)	€/ m ² *
-----------------------	-----------------------------------------------------------------------------------------------------------------	----------	---------------------

NS.ALUT1750PDF	Acrílico duplo, fosco Acrílico doble, opaco Plexiglas double, dépoli Double glazed acrylic, frosted	3+10+3	€/ m ² *
-----------------------	--------------------------------------------------------------------------------------------------------------	--------	---------------------

	Grelha de ventilação em alumínio Rejilla de ventilación de aluminio Grille de ventilation en aluminium Aluminium ventilation grid		Preço sob consulta Precio a consultar Prix sur demande Price on request
--	--------------------------------------------------------------------------------------------------------------------------------------------	--	----------------------------------------------------------------------------------

	Chapa de aço microperfurada Chapa de acero microperforada Tôle d'acier microperforée Micro-perforated steel sheet		Preço sob consulta Precio a consultar Prix sur demande Price on request
--	----------------------------------------------------------------------------------------------------------------------------	--	----------------------------------------------------------------------------------

PT

- Painel construído com perfis de alumínio extrudido e espessura de 40mm
- Janelas em acrílico simples ou duplo (3+10+3mm), transparente ou fosco, chapa cega ou perfurada
- Vedantes em EPDM de grande densidade em todo o perímetro
- Variedade de combinações com painéis sandwich (mod. 40AA/CA/LA)
- Encaixe anti-dedo prevenindo qualquer hipótese de entalamento durante a operação do portão
- Grande visibilidade para o interior e aproveitamento da luz solar

Faturação mínima: 5,5 m²

ES

- Panel construído con perfiles de aluminio extrudido y 40mm de espesor
- Ventanas en acrílico simple o doble (3+10+3mm), transparente o mate, placa ciega o perforada
- Juntas de EPDM de alta densidad en todo el perímetro
- Variedad de combinaciones con paneles sándwich (mod. 40AA/CA/LA)
- Gran visibilidad hacia el interior y aprovechamiento de la luz solar

Facturación mínima: 5,5 m²



FR

- Panneau construit avec des profils en aluminium extrudé et une épaisseur de 40mm
- Fenêtres en acrylique simple ou double (3+10+3mm), transparentes ou mates, aveugles ou perforées
- Joints en EPDM haute densité sur tout le périmètre
- Variété de combinaisons avec des panneaux sandwichs (mod. 40AA/CA/LA).
- Dispositif anti-pince-doigts empêchant toute possibilité de coincement pendant le fonctionnement du portail
- Grande visibilité vers l'intérieur et utilisation de la lumière du soleil

Minimum de facturation: 5,5 m²

EN

- Panel built with extruded aluminium profiles and 40mm thickness
- Windows in single or double acrylic (3+10+3mm), transparent or matte, blind or perforated plate
- Seals in high density EPDM around the perimeter
- Variety of combinations with sandwich panels (mod. 40AA/CA/LA)
- Anti-finger-trap preventing any possibility of entrapment during operation of the gate
- High visibility towards the inside and use of sunlight

Minimum charge: 5,5 m²



PT

As portas LM Alu podem ser aplicadas em sistemas residenciais e industriais, fabricadas em perfis de alumínio extrudido garantem leveza, resistência mecânica e elevada durabilidade.

As portas podem integrar diferentes soluções: painéis sandwich, janelas de acrílico simples ou duplo, e em consonância com as atuais normas de ventilação dispomos de múltiplos modelos.

FR

Les portes LM Alu peuvent être utilisées pour des systèmes résidentiels et industriels ; fabriquées à partir de profilés en aluminium extrudé, elles garantissent légèreté, résistance mécanique et grande durabilité.

Ces portes peuvent intégrer différentes solutions : panneaux sandwich, vitrages en plexiglas simple ou double. Conformément aux normes de ventilation en vigueur, nous proposons de nombreux modèles.

ES

Las puertas LM Alu pueden utilizarse en sistemas residenciales e industriales; fabricadas con perfiles de aluminio extrusionado, garantizan levedad, resistencia mecánica y una gran durabilidad.

Las puertas pueden incorporar diferentes soluciones: paneles sándwich, ventanas de acrílico simple o doble, y, de acuerdo con la normativa vigente en materia de ventilación, disponemos de múltiples modelos.

EN

LM Alu doors are suitable for both residential and industrial applications; manufactured from extruded aluminium profiles, they offer lightness, mechanical strength and high durability.

The doors can incorporate various options: sandwich panels, single or double acrylic glazing, and we offer a wide range of models that comply with current ventilation standards.



- As portas LM Alu podem incorporar, de forma opcional, janelas basculantes integradas nos painéis, constituindo uma solução técnica inovadora que assegura iluminação natural e ventilação controlada, mantendo os níveis de segurança do conjunto, através de sistemas de fecho, articulação e fixação devidamente dimensionados.
- Las puertas LM Alu pueden incorporar, de forma opcional, ventanas basculantes integradas en los paneles, esto constituye una solución técnica innovadora que garantiza la iluminación natural y la ventilación controlada, manteniendo los niveles de seguridad, mediante sistemas de cierre, articulación y fijación debidamente dimensionados.
- Les portes LM Alu peuvent intégrer, en option, des fenêtres basculantes intégrées dans les panneaux, constituant une solution technique innovante qui assure un éclairage naturel et une ventilation contrôlée, tout en maintenant les niveaux de sécurité de l'ensemble, grâce à des systèmes de fermeture, d'articulation et de fixation correctement dimensionnés.
- LM Alu doors can optionally incorporate tilt windows integrated into the panels, providing an innovative technical solution that ensures natural lighting and controlled ventilation while maintaining the security levels of the assembly through properly sized locking, hinging, and fastening systems.



- Acrílico simples / duplo
Transparente ou fosco
- Acrílico simple/doble
Transparente o mate
- Plexiglas simple / double
Transparent ou opaque
- Single/double acrylic
Transparent or frosted



- Chapa microperfurada
- Chapa microperforada
- Tôle microperforée
- Micro-perforated sheet



- Chapa microperfurada quadrada
- Chapa microperforada cuadrada
- Tôle microperforée carrée
- Square micro-perforated sheet



- Grelha de ventilação
- Rejilla de ventilación
- Grille de ventilation
- Venting grille



Painel Standard 80mm
Panel Estándar 80mm
Panneau Standard 80mm
Standard Panel 80mm



PS.080CA00	Branco Blanco Blanc White	RAL9010	€/ m ²
-------------------	------------------------------------	---------	-------------------

Pintura a pedido
Pintura por pedido
Peinture sur demande
Paint on demand

NS.PINT	Catálogo RAL (1 face) Carta RAL (1 cara) Nuancier RAL (1 face) RAL colour chart (1 side)		€/ m ²
----------------	---------------------------------------------------------------------------------------------------	--	-------------------

NS.PINTM	Afinação por amostra (1 face) Afinación por muestra (1 cara) Afination par échantillon (1 face) Sampled colour (1 side)		€/ m ²
-----------------	----------------------------------------------------------------------------------------------------------------------------------	--	-------------------



- Com 80 mm de espessura, o LM 80 garante elevado isolamento térmico e acústico, sendo indicado para ambientes exigentes e aplicações industriais. Destaca-se pela sua robustez, durabilidade e eficiência, oferecendo uma solução fiável para espaços com necessidade de controlo de temperatura.
- Con 80 mm de espesor, el LM 80 garantiza un alto aislamiento térmico y acústico, siendo ideal para entornos exigentes y aplicaciones industriales. Destaca por su robustez, durabilidad y eficiencia, ofreciendo una solución fiable para espacios con necesidad de control de temperatura.
- Avec 80 mm d'épaisseur, le LM 80 assure une excellente isolation thermique et acoustique, étant adapté aux environnements exigeants et aux applications industrielles. Il se distingue par sa robustesse, sa durabilité et son efficacité, offrant une solution fiable pour les espaces nécessitant un contrôle de la température.
- With 80 mm thickness, the LM 80 ensures high thermal and acoustic insulation, making it suitable for demanding environments and industrial applications. It stands out for its robustness, durability and efficiency, providing a reliable solution for spaces requiring temperature control.

PT

Painel sandwich

Em secções de 500mm ou 610mm de altura útil e espessura de 80mm
 Interior em poliuretano expandido de alta densidade e isento de CFC
 Encaixe anti-dedo prevenindo qualquer hipótese de entalamento durante a operação do portão
 Vedante em EPDM embutido no macho do painel
 Chapas de reforço em aço galvanizado, inferior e superior, no interior do painel
 Grande isolamento térmico e acústico

Cara exterior

Chapa de aço de 0,4mm pré-lacada e com tratamento anti-oxidação
 Canelado fino e textura 'stucco'

Cara interior

Chapa de aço de 0,4mm pré-lacada e com tratamento anti-oxidação
 Canelado fino e textura 'stucco', branco Ral 9010

Faturação mínima: 5,5 m²

ES

Panel sandwich

Con secciones de 500mm o 610mm de altura útil e espesor de 80mm
 Interior de poliuretano expandido de gran densidad y libre de CFC
 Encaje antipinzamiento preveniendo cualquier situación de riesgo durante su movimentación
 Goma de EPDM incrustada en el macho del panel
 Área de refuerzo, inferior y superior, de acero galvanizado, en el interior del panel
 Gran aislamiento térmico y acústico

Cara exterior

Chapa de acero 0,4mm prelacada con tratamiento antioxidación
 Acanelado fino y textura 'stucco'

Cara interior

Chapa lisa de acero de 0,4mm prelacada con tratamiento antioxidación
 Acanelado fino y textura 'stucco', blanco ral 9010

Facturación mínima: 5,5 m²



FR

Panneau sandwich

En section de 500mm ou 610mm de hauteur utile et épaisseur de 80mm
 Intérieur en polyuréthane à haute densité et dépourvu de CFC
 Emboîtement anti-pince doigt, évitant toute possibilité de coincement pendant la marche de la porte
 Plaques de renfort en acier galvanisé, inférieures et supérieures, à l'intérieur du panneau
 Joint EPDM encastré dans la partie mâle du panneau
 Forte isolation thermique et acoustique

Coté extérieur

Tôle d'acier de 0,4mm pré-laqué avec traitement antioxydant
 Rainuré fin et texture 'stucco'

Coté intérieur:

Tôle d'acier de 0,4mm pré-laqué avec traitement antioxydant
 Rainuré fin et texture 'stucco', blanc RAL 9010

Minimum de facturation: 5,5 m²

EN

Sandwich panel

In sections of 500mm or 610mm height and thickness of 80mm
 Interior of high density expanded polyurethane, CFC free
 Safe-finger interlocking system preventing any trapping episodes during door's moving cycle
 EPDM rubber seal grooved into the panel's top
 Reinforced panel's structure with galvanized steel strips in top and bottom ends of the panel
 Great thermal and acustic insulation

Outer appearance:

0,4mm galvanized steel plate, pre-powdercoated with anti-corrosion treatment
 Thin ribbed and 'stucco' texture

Inner appearance:

0,4mm galvanized steel plate, pre-powdercoated with anti-corrosion treatment
 Thin ribbed pattern and 'stucco' emboss, pre-powdercoated white RAL 9010

Minimum charge: 5,5 m²

Porta-homem, incluída no portão
Puerta peatonal, suministrada con el portón
Portillon, inclus dans la porte
Wicket door, included with gate



PS.900004	Porta com fechadura de 3 pontos Puerta con cerradura de 3 puntos Porte avec serrure de 3 points Door with 3 points lock	€/ m ²
------------------	----------------------------------------------------------------------------------------------------------------------------------	-------------------

Porta-homem, incluída no portão
Puerta peatonal, suministrada con el portón
Portillon, inclus dans la porte
Wicket door, included with gate

11.100043	Mola de fecho de braço deslizante Cierrapuertas de guía deslizante Ferme-porte avec bras glissière Door closer with slide channel	€/ m ²
02.400511	Kit sensor de segurança magnético s/ fios Kit interruptor de seguridad magnético inalámbrico Kit interrupteur de sécurité magnétique sans fils Kit wireless safety magnetic switch	€/ m ²

PT

- Porta-homem embutida no portão, construída em perfis de alumínio lacado
- Vedantes EPDM em todo o aro da porta e vedante duplo no perfil da soleira para maior estanquicidade
- Perfil de dobradiça muito discreto e resistente, em toda a altura da porta
- Medida standard de referência: largura 800 mm e altura 2000 mm. Estas medidas podem ser alteradas consoante necessidades estruturais. No caso de ter necessidades específicas de obra, indique no seu pedido
- Sentido de abertura obrigatório para o exterior; Sentido standard para a direita (vista exterior)
- Fechadura incluída, com espelhos e puxador à cor do painel
- Em portões com painel almofadado, as medidas da porta-homem estão dependentes do padrão dos painéis
- Soleira reforçada (30mm) para portas com largura até 4000mm
- Soleira reforçada (100 /120mm) para portas com largura superior a 4000mm e até 5500mm

ES

- Puerta peatonal insertada en el portón, fabricada con perfiles de aluminio lacado.
- Juntas de EPDM en todo el marco de la puerta y doble junta en el perfil inferior para una mayor estanqueidad
- Perfil de bisagra muy discreto y resistente, en todo el alto de la puerta.
- Medidas estándar de referencia: ancho 800mm y alto 2000mm. Estas medidas pueden modificarse en función de las necesidades estructurales. Si tiene requisitos de construcción específicos, indíquelo en su pedido
- Dirección de apertura obligatoria hacia el exterior; dirección estándar hacia la derecha (vista exterior)
- Cerradura incluida, con espejos y manilla del color de la puerta.
- En las puertas con panel cuarteron, las medidas de la peatonal dependen del alto
- Perfil inferior reforzado (30mm) para puertas hasta 4000mm de ancho
- Perfil inferior reforzado (100 /120mm) para puertas de más de 4000mm de ancho hasta 5500mm



FR

- Portillon encastré dans la portail, réalisée en profilés d'aluminium laqués
- Joints en EPDM sur l'ensemble du cadre de la porte et double joint sur le profilé de seuil pour une meilleure étanchéité
- Profil de charnière très discret et résistant, sur toute la hauteur de la porte
- Mesures de référence standard: largeur 800mm et hauteur 2000mm. Ces mesures peuvent être modifiées en fonction des besoins structurels. Si vous avez des exigences particulières en matière de construction, veuillez les indiquer dans votre commande
- Sens d'ouverture obligatoire vers l'extérieur ; sens standard vers la droite (vue extérieure)
- Serrure incluse, avec miroirs et poignée dans la couleur du panneau
- Sur les portails avec panneau rembourré, les dimensions de la porte d'homme dépendent du motif des panneaux
- Profil du seuil renforcé (30mm) pour portes d'une largeur maximale de 4000mm
- Profil du seuil renforcé (100 /120mm) pour portes de plus de 4000mm de large jusqu'à 5500mm

EN

- Wicket door embedded into the gate, built of lacquered aluminium profiles
- EPDM seals on the entire door frame (mobile and fixed) and double seal on the threshold profile for greater watertightness
- Very discreet and resistant hinge profile, along the entire height of the door
- Standard reference measurements: width 800mm and height 2000mm. These measurements may be altered according to structural needs. If you have specific construction requirements, please indicate them in your order
- Mandatory opening direction to the outside; standard direction to the right (outside view)
- Lock included, with mirrors and handle in the colour of the panel
- On gates with padded panel, the measurements of the man-door are dependent on the pattern of the panels
- The reinforced threshold (30mm) for doors up to 4000mm wide
- Reinforced threshold (100 /120mm) for doors over 4000mm up to 5500mm

Porta-homem mod. A, incluída no portão
Puerta peatonal mod. A, suministrada con el portón
Portillon mod. A, inclus dans la porte
Wicket door mod. A, included with gate

PL.900001	Porta com fechadura de 2 pontos Puerta con cerradura de 2 puntos Porte avec serrure de 2 points Door with 2 points lock	€/ m ²
------------------	----------------------------------------------------------------------------------------------------------------------------------	-------------------

Porta-homem mod. B, incluída no portão
Puerta peatonal mod. B, suministrada con el portón
Portillon mod. B, inclus dans la porte
Wicket door mod. B, included with gate

PL.900002	Porta com fechadura de 1 ponto Puerta con cerradura de 1 punto Porte avec serrure de 1 point Door with 1 point lock	€/ m ²
------------------	------------------------------------------------------------------------------------------------------------------------------	-------------------

Opções, Porta-homem
Opciones, Puerta peatonal
Options, Portillon
Options, Wicket door

11.100043	Mola de fecho de braço deslizante Cierrapuertas de guía deslizante Ferme-porte avec bras glissière Door closer with slide channel	€/ m ²
02.400511	Kit sensor de segurança magnético s/ fios Kit interruptor de seguridad magnético inalámbrico Kit interrupteur de sécurité magnétique sans fils Kit wireless safety magnetic switch	€/ m ²

PT

- Duas possibilidades de porta-homem embutida no portão.
- Sentido de abertura obrigatório para o interior.
- Largura de passagem da porta-homem: 600mm máximo.

Especificações do modelo A:

- Porta completamente discreta
- Régua de alinhamento da porta-homem em aço galvanizado, lacado a branco, com dobradiça embutida e carrinho para guia superior.
- Localização obrigatória da porta no primeiro painel do lado do fecho.
- Fechadura de 2 pontos verticais incluída, trancando na régua de alinhamento e na guia inferior.

Especificações do modelo B:

- Construída totalmente em perfis de alumínio, com painel igual ao do portão.
- Fechadura de 1 ponto incluída, montada com puxador ou torniquete.
- Localização possível em qualquer painel do portão excepto no painel de abertura.

ES

- Dos posibilidades de puertas de hombre integradas en el portón.
- Dirección de apertura obligatoria hacia el interior.
- Ancho de paso de la puerta de hombre: 600mm como máximo.

Especificaciones del modelo A:

- Puerta completamente discreta.
- Regla de alineación de la puerta peatonal de acero galvanizado lacado blanco, con bisagra incrustada y soporte rodante para la guía superior.
- Ubicación obligatoria en el primero panel del lado de la apertura.
- Cerradura de 2 puntos verticales suministrada, para bloqueo en la regla de alineación y guía inferior.

Especificaciones del modelo B:

- Construido íntegramente en perfiles de aluminio, con panel igual al de la puerta.
- Cerradura de 1 punto incluida, montada con manilla o torniquete.
- Ubicación posible en cualquier panel de la puerta, excepto en el panel de apertura.



FR

- Deux possibilités de porte d'homme intégrées au portail.
- Sens d'ouverture obligatoire vers l'intérieur.
- Largeur de passage de la porte d'homme: 600mm maximum.

Spécifications du modèle A:

- Porte totalement discrète.
- Règle d'alignement du portillon en acier galvanisé laqué blanc, avec charnière intégré et charriot pour le guide supérieur.
- Lieu obligatoire ddu portillon sur le première panneau de l'ouverture.
- Serrure de 2 points verticaux incluse, verrouillage dans la règle d'alignement et guide inférieur.

Spécifications du modèle B:

- Construit entièrement en profilés d'aluminium, avec un panneau égal à celui du portail.
- Serrure à 1 point incluse, montée avec une poignée ou un tourniquet.
- Emplacement possible sur n'importe quel panneau du portail, sauf le panneau d'ouverture.

EN

- Two possible options for built-in wicket door.
- Obligatory opening direction for the interior.
- Passage width of wicket door: 600mm.

Model A specifications:

- Completely discrete door.
- Wicket door alignment plate of white coated galvanized steel, with built-in hinge and upper guide hanger.
- Obligatory location of the door on the first panel on the opening side.
- included with a 2 points vertical lock, clamping to the alignment plate and bottom guide.

Model B specifications:

- Produced entirely of aluminium profiles and in the same panel as the door.
- included with a 1 point lock, mounted with a handle or a ring handle.
- Assembly possible in any door panel.

PORTA DE SERVIÇO LATERAL

PUERTA PEATONAL LATERAL / PORTE PIÉTONNE LATÉRALE / PEDESTRIAN LATERAL DOOR

Porta de serviço lateral, textura woodgrain Puerta peatonal lateral, textura woodgrain Porte piétone latéral, texture woodgrain Pedestrian lateral door, woodgrain texture		Fechadura 1 ponto Cerradura 1 punto Serrure 1 point 1 point lock		Fechadura 3 pontos Cerradura 3 puntos Serrure 3 point 3 point lock		Barra anti-pânico Barra antipánico Barre anti-panique Panic bar	
Branco / Blanco / Blanc / White	RAL 9010	PS.801000	€/uni.	PS.801100	€/uni.	PS.801200	€/uni.
Bege / Beige / Beige / Beige	RAL 1015	PS.801006	€/uni.	PS.801106	€/uni.	PS.801206	€/uni.
Cinza / Gris / Gris / Grey	RAL 9006 RAL 9007 RAL 7011 RAL 7016	PS.801007 PS.801015 PS.801011 PS.801012	€/uni.	PS.801107 PS.801115 PS.801111 PS.801112	€/uni.	PS.801207 PS.801215 PS.801211 PS.801212	€/uni.
Verde / Verde / Vert / Green	RAL 6005 RAL 6009	PS.801001 PS.801010	€/uni.	PS.801101 PS.801110	€/uni.	PS.801201 PS.801210	€/uni.
Castanho / Marrón / Marron / Brown	RAL 8014	PS.801002	€/uni.	PS.801102	€/uni.	PS.801202	€/uni.
Azul / Azul / Bleu / Blue	RAL 5010	PS.801008	€/uni.	PS.801108	€/uni.	PS.801208	€/uni.
Vermelho / Rojo / Rouge / Red	RAL 3000	PS.801009	€/uni.	PS.801109	€/uni.	PS.801209	€/uni.
Carta RAL / Carta RAL / Nauncier RAL / RAL chart		PS.801099	€/uni.	PS.801199	€/uni.	PS.801299	€/uni.
Afinação por amostra / Ajuste por muestra Accordage par échantillon / Colour tuning		PS.801098	€/uni.	PS.801198	€/uni.	PS.801298	€/uni.
Porta de serviço lateral, textura liso Puerta peatonal lateral, textura lisa Porte piétone latéral, texture lisse Service lateral door, super flat texture		Fechadura 1 ponto Cerradura 1 punto Serrure 1 point 1 point lock		Fechadura 3 pontos Cerradura 3 puntos Serrure 3 point 3 point lock		Barra anti-pânico Barra antipánico Barre anti-panique Panic bar	
Branco / Blanco / Blanc / White	RAL 9010	PS.801020	€/uni.	PS.801120	€/uni.	PS.801220	€/uni.
LM Sablé	RAL 7016	PS.801025	€/uni.	PS.801125	€/uni.	PS.801225	€/uni.
LM Sablé Noir	Ral 9005	PS.801028	€/uni.	PS.801128	€/uni.	PS.801228	€/uni.
LM Silver		PS.801091	€/uni.	PS.801191	€/uni.	PS.801291	€/uni.
LM Inox		PS.801094	€/uni.	PS.801194	€/uni.	PS.801294	€/uni.
LM Corten		PS.801093	€/uni.	PS.801193	€/uni.	PS.801293	€/uni.
Imitação de madeira clara / escura Imitación de madera clara / oscura Imitation bois clair / foncé Light / Drark timber coated design		PS.801013 PS.801014	€/uni.	PS.801113 PS.801114	€/uni.	PS.801213 PS.801214	€/uni.
Imitação de madeira clara / escura, 2 lados Imitación de madera clara / oscura, dos caras Imitation bois clair / foncé, deux faces Light / Drark timber coated design, two-sided		PS.801073 PS.801074	€/uni.	PS.801173 PS.801174	€/uni.	PS.801273 PS.801274	€/uni.
Carta RAL / Carta RAL / Nauncier RAL / RAL chart		PS.801029	€/uni.	PS.801129	€/uni.	PS.801229	€/uni.
Afinação por amostra / Afinación por muestra Afination par échantillon / Sampled colour		PS.801028	€/uni.	PS.801128	€/uni.	PS.801228	€/uni.
Porta de serviço lateral, modelo LM ALU Puerta peatonal lateral, modelo LM ALU Porte piétone latéral, modèle LM ALU Service lateral door, model LM ALU		Fechadura 1 ponto Cerradura 1 punto Serrure 1 point 1 point lock					
Alumínio bruto, acrílico simples transparente Aluminio bruto, acrílico simple transparente Aluminium bruit, plexiglas simple transparent Plain aluminium, single glazed transparent acrylic		PS.8010AL	€/uni.				

PT

Porta de serviço construída com perfis de alumínio lacado e secções de painel condizente às do portão seccionado (possível em painel sandwich ou LM Alu)

Vedantes EPDM em todo o aro da porta (móvel e fixo) para maior estanquidade

Medida standard de referência: largura 800mm, altura 2000mm, outras medidas mediante consulta.

Em portas de painel almofadado, as medidas estão dependentes do padrão do painel.

Aplicação dentro de vão com sentido de abertura opcional

Fechadura de 1 ou 3 pontos incluída, com espelhos e puxador à cor do painel.

Em portas encostadas ao portão é necessária a aquisição de uma ombreira falsa para a sua separação. As portas com altura inferior ao vão poderão ser acompanhadas por uma padieira falsa, em painel ou chapa canelada, acabada com perfil em toda a volta

ES

Puerta de servicio fabricada con perfiles de aluminio lacado y secciones de panel a juego con las de la puerta seccional (posibilidad de panel sándwich o LM Alu)

Juntas de EPDM en todo el marco de la puerta (móvil y fija) para aumentar la estanqueidad

Medida de referencia estándar: anchura 800mm, altura 2000mm, otras dimensiones a petición.

En el caso de las puertas con paneles acolchados, las medidas dependen del estándar del panel.

Aplicación dentro de una puerta con dirección de apertura opcional

Cerradura de 1 o 3 puntos incluida, con espejos y asa en el color del panel.

En el caso de las puertas enrasadas con el portón, es necesario adquirir una jamba falsa para separarla. Las puertas con una altura inferior al vano pueden ir acompañadas de una falsa jamba, de panel o chapa ondulada, acabada con un perfil en todo su contorno



FR

Porte de service en profilés d'aluminium laqués et sections de panneaux assorties à celles de la porte sectionnelle (panneau sandwich ou LM Alu possible)

Joints en EPDM sur l'ensemble du cadre de la porte (mobile et fixe) pour une meilleure étanchéité.

Mesure de référence standard: largeur 800mm, hauteur 2000mm, autres dimensions sur demande.

Pour les portes à panneaux rembourrés, les mesures dépendent du standard du panneau.

Application dans un passage de porte avec sens d'ouverture optionnel

Serrure 1 ou 3 points incluse, avec miroirs et poignée dans la couleur du panneau.

Pour les portes affleurant le portail, il est nécessaire d'acheter un faux montant pour le séparer. Les portes dont la hauteur est inférieure à la portée peuvent être accompagnées d'un faux montant, en panneau ou en tôle ondulée, terminé par un profilé tout autour.

EN

Service door made of lacquered aluminium profiles and panel sections matching those of the sectional door (sandwich panel or LM Alu possible)

EPDM seals on entire door frame (mobile and fixed) for increased watertightness

Standard reference measurement: width 800mm, height 2000mm, other dimensions on request.

For padded-panel doors, the measurements depend on the standard of the panel.

Application within a doorway with optional direction of opening

1 or 3 point lock included, with mirrors and handle in the colour of the panel.

For doors flush with the gate, it is necessary to purchase a false jamb to separate it. Doors with a height below the span may be accompanied by a false jamb, in panel or corrugated sheet metal, finished with a profile all round.

CARACTERÍSTICAS TÉCNICAS

CARACTERÍSTICAS TÉCNICAS / CARACTÉRISTIQUES TECHNIQUES
TECHNICAL SPECIFICATIONS



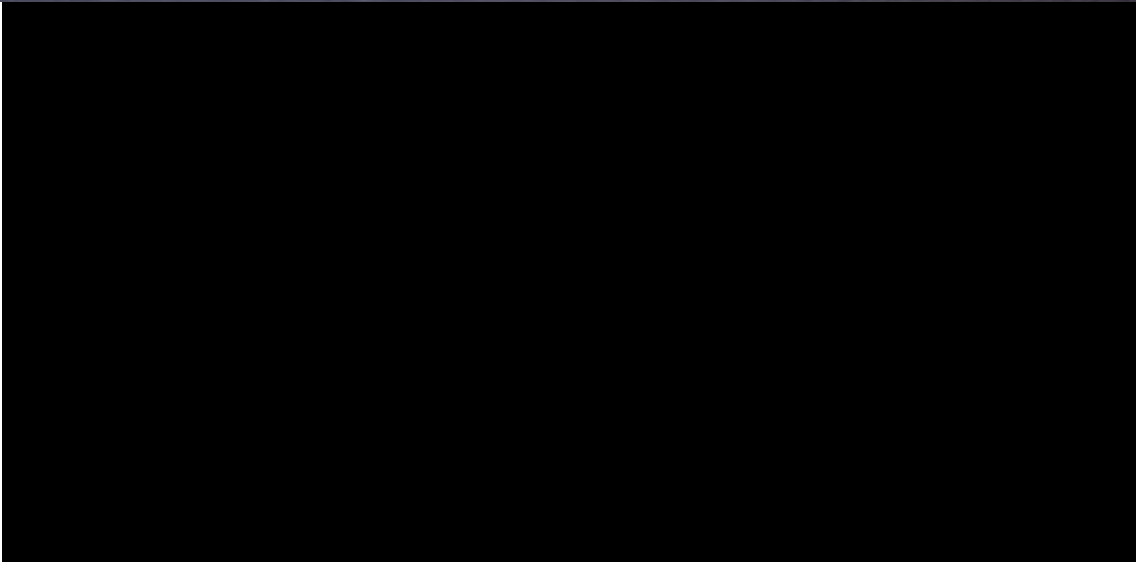
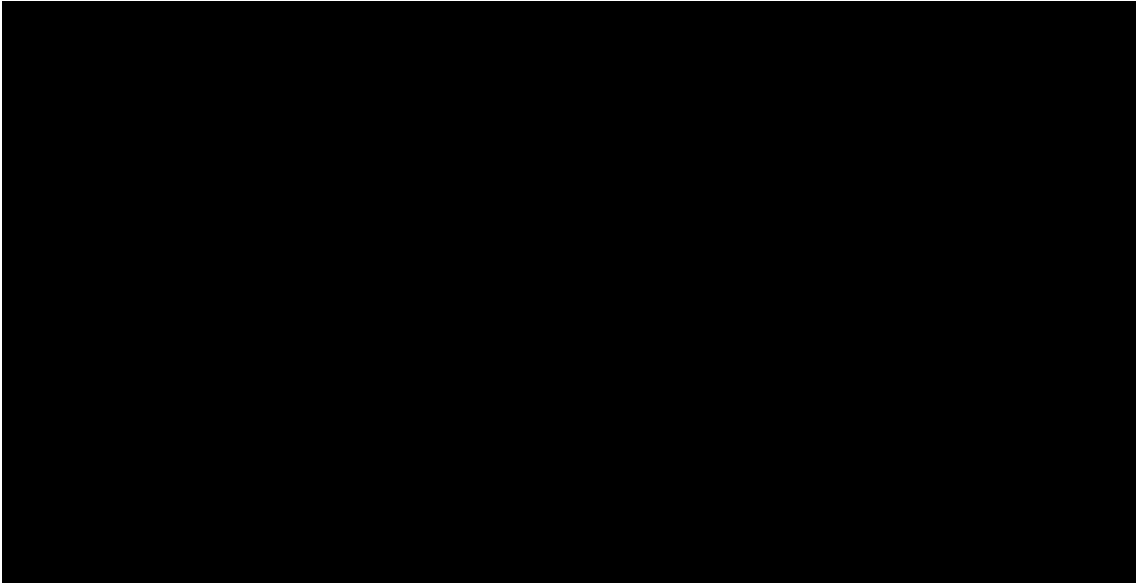

CONFIGURAÇÃO EASY SPRING - MOLAS LATERAIS

CONFIGURACIÓN EASY SPRING - MUELLES LATERALES / CONFIGURATION EASY SPRING - RESSORTS LATÉRAUX
EASY SPRING CONFIGURATION - LATERAL SPRINGS

PT

As portas Easy Spring estão equipadas com um sistema de molas de extensão único, fácil de instalar e o mais utilizado no mercado. Fabricado para portas seccionadas até 4500 mm de largura, 2700mm de altura, peso máximo de 130 kg, ombreiras laterais mínimas de 100 mm e a padieira de 100 mm.

FR

Les portes Easy Spring sont équipées d'un système unique de ressorts d'extension, facile à installer et le plus utilisé sur le marché. Fabriquées pour des portes sectionnelles jusqu'à 4500 mm de large, 2700 mm de haut, avec un poids maximum de 130 kg, des montants latéraux minimum de 100 mm et retombée de linteau de 100 mm.

ES

Las puertas Easy Spring están equipadas con un exclusivo sistema de muelles de extensión fácil de instalar y el más utilizado del mercado. Fabricadas para puertas seccionales de hasta 4500 mm de ancho, 2700 mm de alto, con un peso máximo de 130 kg, marcos laterales mínimos de 100 mm y dintel de 100 mm.

EN

Easy Spring doors are equipped with a unique extension spring system that is easy to install and the most widely used on the market. Manufactured for sectional doors up to 4500 mm wide, 2700 mm high, with a maximum weight of 130 kg, minimum side jambs of 100 mm and fascia of 100 mm.



- A placa de cobertura em aço maciço permite uma estrutura mais estável. Reforça a ligação entre calhas, aumentando assim a estabilidade. Esta cobertura evita o entalamento de mãos e dedos
- La sólida placa de cubierta de acero proporciona una estructura más estable. Refuerza la unión entre las guías, aumentando así la estabilidad. Esta cubierta también evita que se queden atrapados manos o dedos.
- La plaque en acier assure une construction plus stable. Il renforce le lien entre les rails. La plaque empêche également de se coincer les mains et les doigts.
- The solid steel cover plate provides a more stable construction. It reinforces the link between the frame and the rails and, thus creating increased stability. The plate also prevents entrapment of hands and fingers.

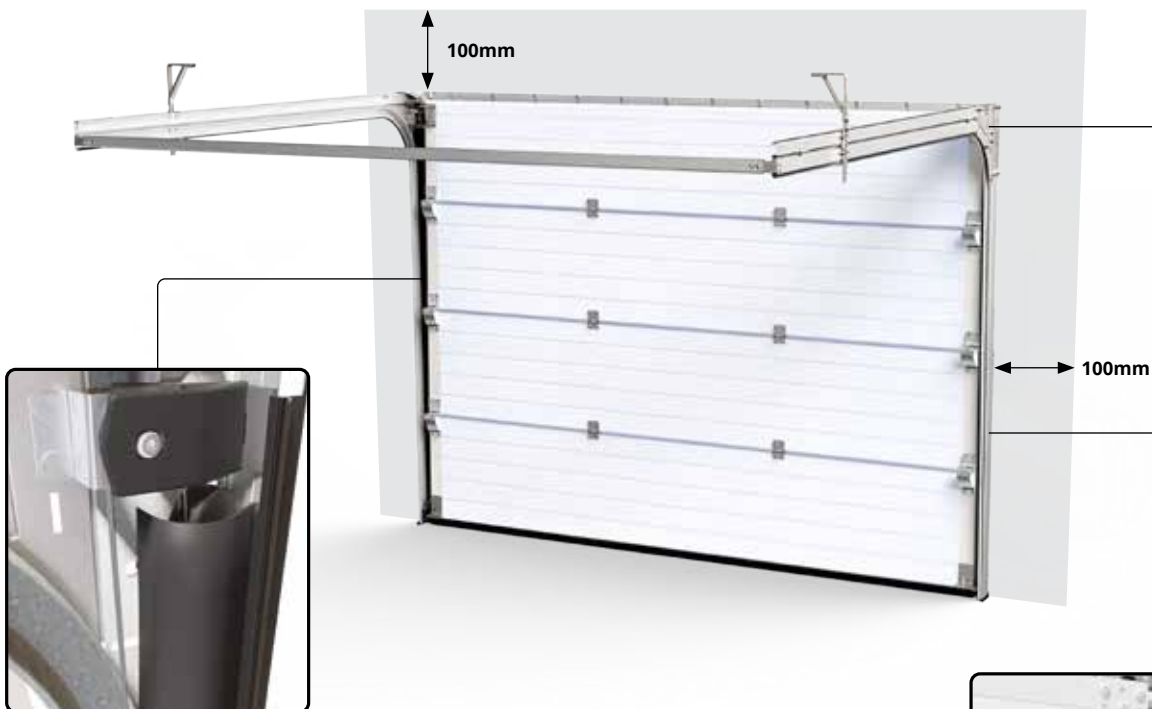

- Cobertura para proteger as suas mãos das molas. Fica esteticamente bem e evita o depósito de sujidade.
- Cubierta para proteger las manos de los muelles. Tiene buena estética y evita que se deposite la suciedad.
- Cache pour protéger les mains des ressorts, très esthétique et empêchant les poussières de se déposer.
- Cover to protect your hands from the springs. Aesthetically pleasing and prevents the deposit of dirt.



- As molas laterais são fornecidas pré-montadas. Não são necessários parafusos ou ferramentas adicionais, e tem um tempo de vida útil de pelo menos 15.000 ciclos.
- Los muelles laterales se suministran premontados. No se necesitan tornillos ni herramientas adicionales, y tienen una vida útil de al menos 15.000 ciclos.
- Les ressorts latéraux sont livrés pré-assemblés. Ils ne nécessitent ni vis ni outils supplémentaires et ont une durée de vie d'au moins 15 000 cycles.
- The lateral springs are supplied pre-assembled. No additional screws or tools are required, and they have a lifespan of at least 15,000 cycles.

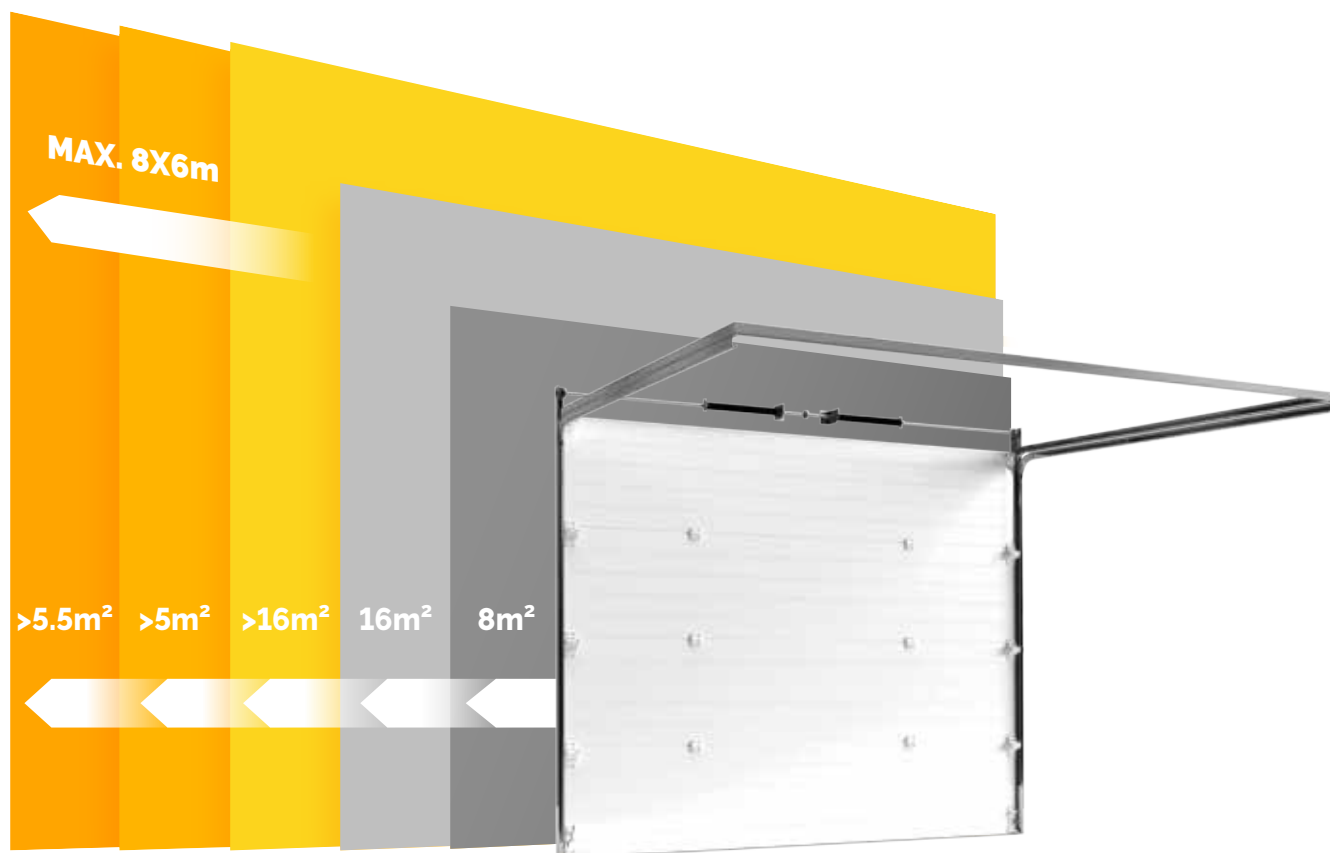

01

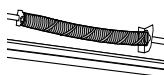

- Molas de torsão em aço galvanizado ou fosfatado para 25000 ciclos e topos de mola em alumínio fundido. Sistema de segurança de ruptura de molas
- Muelles de torsión de acero galvanizado o fosfatado para 25000 ciclos y topos de muelles de aluminio fundido. Sistema de seguridad de muelles
- Ressorts de torsion en acier galvanisé ou phosphaté pour 25000 cycles et avec dessus de ressort en aluminium fondu. Système de sécurité de rupture de ressort
- Torsion springs of galvanized or phosphate steel for 25000 cycles and spring cones of casted aluminium. Spring rupture safety device

02

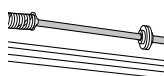

- Veio oco ou maciço em aço galvanizado. Inteiro ou repartido com união ajustável em ferro fundido
- Eje hueco o macizo de acero galvanizado. Entero o repartido con acoplamiento ajustable de hierro fundido
- Axe creux ou massif en acier galvanisé. Entier ou réparti avec union ajustable en fer fondu
- Hollow or solid galvanized steel shaft. Whole or divided with casted iron adjustable coupler

03

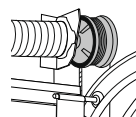

- Roldanas em alumínio fundido com cabo de aço galvanizado
- Poleas de aluminio fundido con cable de acero galvanizado
- Poulies en aluminium fondu avec câble en acier galvanisé
- Pulleys of casted aluminium with galvanized steel cable

04

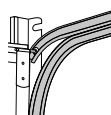

- Calhas verticais e horizontais em aço galvanizado
- Guías verticales y horizontales en acero galvanizado
- Guides verticales et horizontales en acier galvanisé
- Vertical and horizontal guides in galvanized steel

05

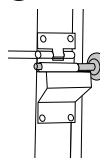

- Rodízios com veio em aço galvanizado ou aço inox com roda em nylon
- Rodillos con eje de acero galvanizado ou acero inoxidable con rueda de nylon
- Galets avec axe en acier galvanisé ou acier inox et roulette en nylon
- Rollers with galvanized steel shaft or stainless steel and white nylon

06

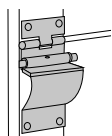

- Dobradiças laterais residenciais
- Bisagras laterales residenciales
- Charnières lateraux résidentielles
- lateral High strenght residential hinges

14

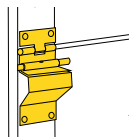

- Dobradiças reforçadas com ponto de lubrificação
- Bisagras reforzadas con agujero de lubricación
- Charnières renforcées avec point de lubrification
- Reenforced hinges with lubrication point

07

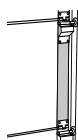

- Topos de painel em chapa de aço pré-lacada para grande duração e melhor fixação da ferragem
- Cantoneras de panel en chapa de acero prelacado para larga duración y una mejor fijación del herraje
- Montants d'extrêmes de panneau en acier pré-laqué pour une grande durée et meilleure fixation des ferrures
- Top side caps of precoated galvanized steel for high resistance and best hardware fixation

15

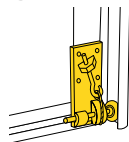

- Suportes de cabo ajustável em alumínio fundido
- Soportes de cable ajustables de aluminio fundido
- Supports de câble ajustable en aluminium fondu
- Adjustable cable fixing bracket of casted aluminium

08

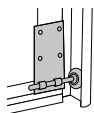

- Suportes de cabo simples em aço galvanizado
- Soportes de cable simple de acero galvanizado
- Support de câble simple en acier galvanisé
- Regular cable fixing bracket of galvanized steel

16

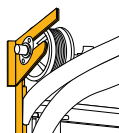

- Guias verticais montadas com suporte de veio tipo 'garfo' duplo
- Guías verticales con soporte de eje tipo 'horquilla' doble
- Rails verticaux avec support d'arbre type 'fourchette' double
- Vertical guides with double fork-type shaft support

09

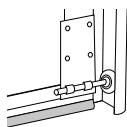

- Perfis de remate em chapa de aço galvanizado, pré-lacada a preto e vedantes em EPDM preto
- Perfiles de remate en chapa de acero galvanizado, prelacado negro y gomas de EPDM negro
- Profils aux extrémités en acier galvanisé pré-laqué en noir et joints d'étanchéité en EPDM noir
- Top and bottom profiles of galvanized steel, black pre-coated and black

18

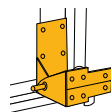

- Sistema de segurança de ruptura de cabos (para-quadras) em aço galvanizado
- Sistema de seguridad de rotura de cables (paracaídas) de acero galvanizado
- Système de sécurité de rupture de câble (pare-chutes) en acier galvanisé
- Cable break safety device (parachute) of galvanized steel

10



- Puxador de Sobrepor LMP
- Tirador de superposición LMP
- Poignée de tirage superposée LMP
- Overlay LMP pull handle

19

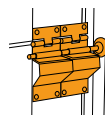

- Dobradiças laterais duplas, em aço galvanizado
- Bisagras laterales dobles, de acero galvanizado
- Charnières latérales doubles, en acier galvanisé
- Double lateral hinges of galvanized steel

11

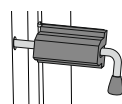

- Trinco lateral em aço galvanizado com veio redondo maciço
- Cerrojo de acero galvanizado con eje redondo macizo
- Verrou latéral en acier galvanisé avec un axe massif
- Lateral bolt with solid round bar, galvanized steel

20



- Perfil de ligação traseira das calhas horizontais em aço galvanizado
- Galga trazera de unión de guías horizontales en acero galvanizado
- Barre d'encartement pour rails horizontaux en acier galvanisé
- Horizontal tracks stabiliser profile of galvanized steel

13

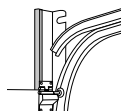

- Vedantes laterais em PVC vulcanizado preto
- Gomas laterales de PVC vulcanizado negro
- Joints latéraux en PVC vulcanisés noir
- Side seals of black vulcanized PVC

21

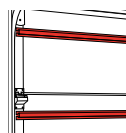

- Perfis de reforço 'ómega' em aço galvanizado, em todos os paineis
- Perfiles de refuerzo 'omega' de acero galvanizado, en todos los paneles
- Profil de renfort 'omega' en acier galvanisé, dans tous les panneaux
- Reenforcement 'omega' profile of galvanized steel, on all panels

CALHAS PARA PORTAS SECCIONADAS

GUIAS PARA PUERTAS SECCIONALES / RAILS POUR PORTES SECTIONNELLES
SECTIONAL DOOR OPTIONS FOR RAILS

Calha vertical / padieira Guía vertical / dintel Rail vertical / linteau Vertical lift / headroom

Calhas com abraçadeiras de reforço
Veio maciço
Perfil de união traseira
Capacidade máxima das molas: 25 000 ciclos
Pára-quadras

Guías con abrazaderas de refuerzo
Eje macizo
Perfil de acoplamiento trasero de guías
Capacidad máxima de los muelles: 25 000 ciclos
Paracaídas

Rails renforcés avec supports
Arbre massif
Profil d'union arrière des guides
Capacité maximale des ressorts: 25 000 cycles
Parachutes

Rails reinforced by plates
Solid shaft
Rear-end tracks connection profile
Maximum springs capacity: 25 000
Parachutes

Calha semi-vertical / padieira Guía sobreelevada / dintel Rail semi-vertical / linteau High lift / headroom

Guías horizontais em curva simples
Calhas com abraçadeiras de reforço
Veio maciço
Perfil de união traseira
Capacidade máxima das molas: 25 000 ciclos
Pára-quadras

Guías horizontales de curva simple
Guías con abrazaderas de refuerzo
Eje macizo
Perfil de acoplamiento trasero de guías
Capacidad máxima de los muelles: 25 000 ciclos
Paracaídas

Rails horizontaux à courbe simple
Rails renforcés avec supports
Arbre massif
Profil d'union arrière des guides
Capacité maximale des ressorts: 25 000 cycles
Parachutes

Single curve horizontal rails
Rails reinforced by plates
Solid shaft
Rear-end tracks connection profile
Maximum springs capacity: 25 000 cycles
Parachutes

Calha normal / padieira Guía normal / dintel Rail normal / linteau Normal lift / headroom

Guías horizontais em curva simples
Veio oco
Capacidade máxima das molas: 100 000 ciclos

Guías horizontales de curva simple
Eje tubular
Capacidad máxima de los muelles: 100 000 ciclos

Rails horizontaux à courbe simples
Arbre creux
Capacité maximale des ressorts: 100 000 cycles

Single curve horizontal rails
Hollow shaft
Maximum springs capacity: 100 000 cycles

H + 500MM

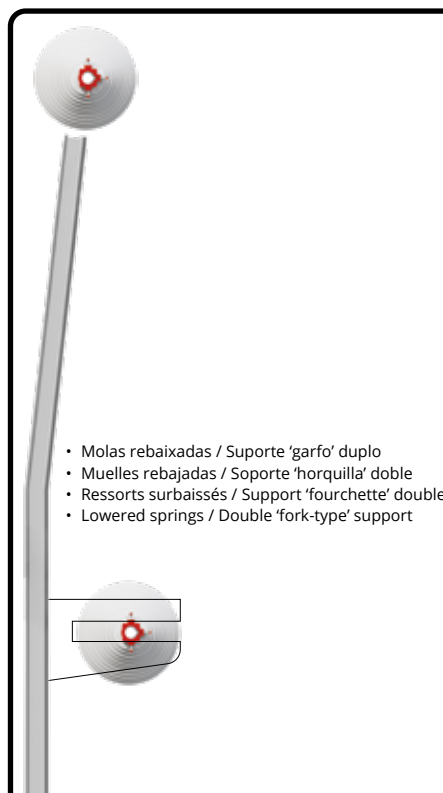

- Molas rebajadas / Soporte 'garfo' duplo
- Muelles rebajadas / Soporte 'horquilla' doble
- Ressorts surbaissés / Support 'fourchette' double
- Lowered springs / Double 'fork-type' support

MIN. 700MM

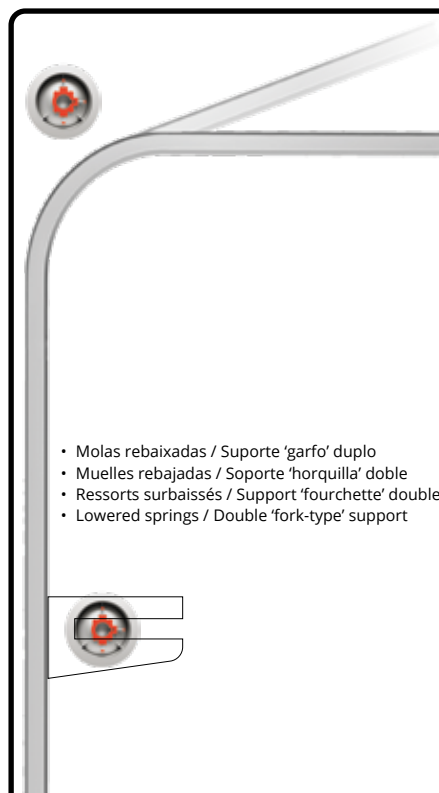

- Molas rebajadas / Soporte 'garfo' duplo
- Muelles rebajadas / Soporte 'horquilla' doble
- Ressorts surbaissés / Support 'fourchette' double
- Lowered springs / Double 'fork-type' support

300 > 500MM

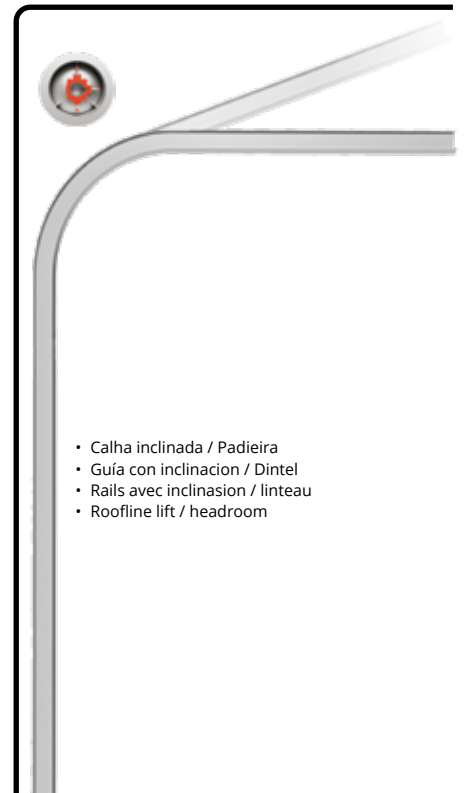

- Calha inclinada / Padieira
- Guía con inclinación / Dintel
- Rails avec inclinaison / linteau
- Roofline lift / headroom

100MM OMBREIRA MÍNIMA / MARCO MÍNIMO / ÉCOINÇON MINIMUM / MINIMUM JAMB

Calha dupla / padieira
Guía doble / dintel
Rail double / linteau
Low lift / headroom

Guias horizontais em curva dupla
Veio oco
Capacidade máxima das molas: 50 000 ciclos
Altura máxima da porta: 3800mm

Guias horizontales de curva doble
Eje tubular
Capacidad máxima de los muelles: 50 000 ciclos
Altura máxima de la puerta: 3800mm

Rails horizontaux à courbe double
Arbre creux
Capacité maximale des ressorts: 50 000 cycles
Hauteur maximale de la porte: 3800mm

Double curve horizontal rails
Hollow shaft
Maximum springs capacity: 50 000 cycles
Maximum door height: 3800mm

Calha dupla reduzida / padieira
Guía doble reducida / dintel
Rail double réduit / linteau
Very low lift / headroom

Guias horizontais em curva dupla reduzida
Veio oco
Capacidade máxima das molas: 50 000 ciclos
Sistema de segurança de molas reduzido
Altura máxima da porta: 2900mm

Guias horizontales de curva doble reducida
Eje tubular
Capacidad máxima de los muelles: 50 000 ciclos
Sistema de seguridad de muelles reducido
Altura máxima de la puerta: 2900mm

Rails horizontaux à courbe double réduite
Arbre creux
Capacité maximale des ressorts: 50 000 cycles
Système de sécurité de ressorts réduits
Hauteur maximale de la porte: 2900mm

Reduced double curve horizontal rails
Hollow shaft
Maximum springs capacity: 50 000 cycles
Reduced spring rupture safety device
Maximum door height: 2900mm

Molas atrás / padieira
Muelles atrás / dintel
Ressorts arrière / linteau
Rear mounted springs / headroom

Guias horizontais em curva dupla
Veio oco
Dobradiça de topo para calha dupla
Capacidade máxima das molas: 50 000 ciclos
Altura máxima da porta: 3800mm

Guias horizontales de curva doble
Eje tubular
Bisagra de tope para guía doble
Capacidad máxima de los muelles: 50 000 ciclos
Altura máxima de la puerta: 3800mm

Rails horizontaux à courbe double
Arbre creux
Charnière supérieure pour rail double
Capacité maximale des ressorts: 50 000 cycles
Hauteur maximale de la porte: 3800mm

Double curve horizontal rails
Hollow shaft
Top hinge for double rail
Maximum springs capacity: 50 000 cycles
Maximum door height: 3800mm

200 > 290MM

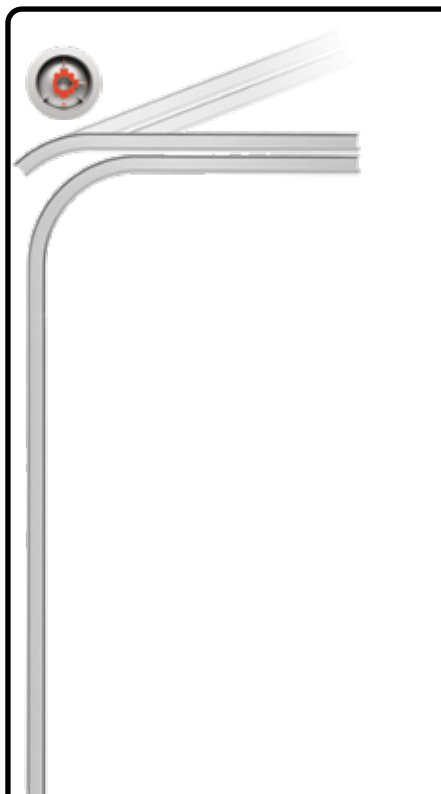

150 > 190MM

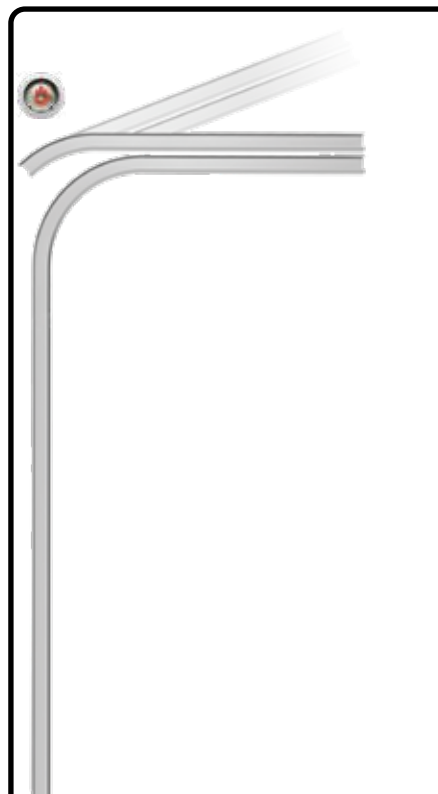

MIN. 100MM

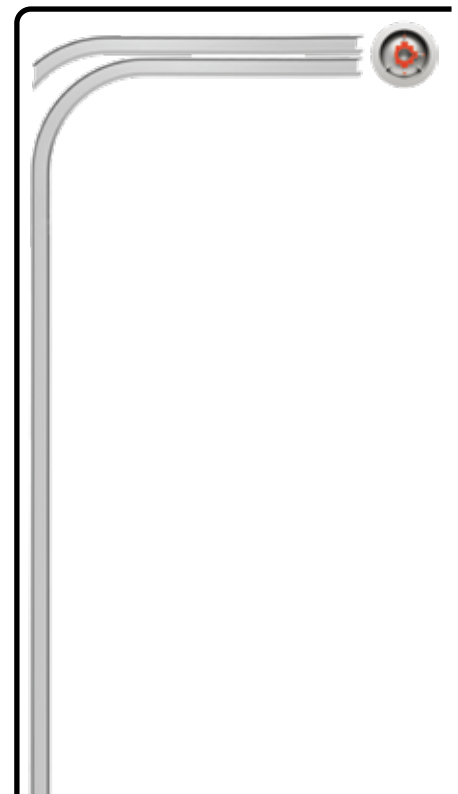

80MM OMBREIRA MÍNIMA / MARCO MÍNIMO / ÉCOINÇON MINIMUM / MINIMUM JAMB

OPÇÕES E ACESSÓRIOS DE PORTAS SECCIONADAS

OPCIONES Y ACCESORIOS PARA PUERTAS SECCIONALES / OPTIONS ET ACCESSOIRES POUR PORTES SECTIONNELLES
SECTIONAL DOOR OPTIONS AND ACCESSORIES

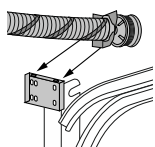

Sistema 'Clip-On' para calhas, incluído na porta
Sistema 'Clip-On' para guías, suministrado con la puerta
Système 'Clip-On' pour rails, inclu dans la porte
'Clip-On' system for tracks, included with door

NS.200220 'Clip-On', para portas até 3,88m de altura
'Clip-On', para puertas de hasta 3,88m de alto
'Clip-On', pour portes jusqu'à 3,88m d'hauteur
'Clip-On', for doors with maximum height of 3,88m € / par *

Sistema 'Clip-On' para calhas, industrial
Sistema 'Clip-On' para guías, industrial
Système 'Clip-On' pour rails, industriel
'Clip-On' system for tracks, industrial

NS.200225 'Clip-On', para portas industriais
'Clip-On', para puertas industriales
'Clip-On', pour portes industrielles
'Clip-On', for industrial doors € / m² *

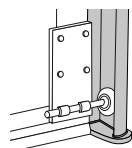

Acessórios, proteção de calhas
Accesorios, protección de guías
Accessoires, protection de guides
Accessories, tracks' protection

03.30696 Proteção inferior de calhas, PVC preto
Protección inferior de guías, PVC negro
Protection inférieure de rails, PVC noir
Bottom-end tracks protection, black PVC € / par



Sistema de molas LM Easy Spring
Sistema de muelles LM Easy Spring
Système de ressorts LM Easy Spring
Spring system LM Easy Spring

Kit montagem LM Easy Spring
Kit de montaje LM Easy Spring
Kit d'assemblage LM Easy Spring
Assembly kit LM Easy Spring (sob consulta)

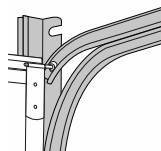

Calhas em aço galvanizado, incluídas na porta
Guías de acero galvanizado, suministradas con la puerta
Rails en acier galvanisé, incluent dans la porte
Galvanized steel tracks, included with door

NS.200216 Calha com inclinação
Guía inclinada
Rail avec inclinaison
Roofline angled track € / par*

NS.200211 Calha semi-vertical
Guía sobreelevada
Rail semi-vertical
High lift track € / par*

NS.200215 Calha vertical
Guía vertical
Rail vertical
Vertical lift track € / par*

Opção, Calhas e ferragem
Opción, Guías y herraje
Option, Rails et ferrures
Option, Tracks and hardware

NS.CGL Calhas lacadas, aço galv.
Guías lacadas, acero galv.
Rails laqués, acier galv.
Powdercoated tracks, gal. steel € / par *

NS.FL Ferragem lacada, aço galv.
Herraje lacado, acero galv.
Ferrures laqués, acier galv.
Pow. hardware, gal. steel Branco Blanco Blanc white € / m² *
Outro Ral. Autre Ral. Otro Ral. Other Ral. € / m² *

NS.FINOX1 Calhas e ferragem, aço inox
NS.FINOX2 Guías y herraje, acero inox
NS.FINOX3 Rails et ferrure, acier inox
Tracks and hardware, sta. steel <10m²
10m² > <15m²
>15m² € / m² *

NS.ALU Calhas e ferragem, alu. bruto
Guías y herraje, aluminio bruto
Rails et ferrure, aluminium bruit
Tracks and hardware, aluminium (sob consulta)

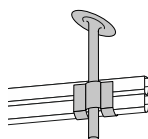

Suportes de fixação ao tecto, aço galvanizado
Soportes de fijación al techo, acero galvanizado
Supports de fixation au plafond, acier galvanisé
Ceiling fixing brackets, galvanized steel

03.200400 Suporte T
Soporte T
Support T
T bracket 300mm € / uni

03.200410 Suporte T
Soporte T
Support T
T bracket 600mm € / uni

03.200420 Suporte T
Soporte T
Support T
T bracket 1000mm € / uni

Opção, Suportes lacados branco RAL 9010
Opción, Soportes lacados blanco RAL 9010
Option, Supports laqués blanc RAL 9010
Option, White powdercoated brackets, RAL 9010

03.200409 Suporte T
Soporte T
Support T
T bracket 300mm € / uni

03.200419 Suporte T
Soporte T
Support T
T bracket 600mm € / uni

03.200429 Suporte T
Soporte T
Support T
T bracket 1000mm € / uni

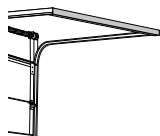

Perfil de ligação traseira de calhas, incluído na porta
Galga trazera de unión de guías, suministrado con la puerta
Barre d'encadrement pour rails, inclus dans la porte
Tracks stabilizer profile, included with door

03.301999	Perfil 'J', aço galvanizado Perfil 'J', acero galvanizado Profil 'J', acier galvanisé 'J' shaped profile, galvanized steel	€ / ml
------------------	-------------------------------------------------------------------------------------------------------------------------------------	--------

Opção, Molas, acresce ao valor do portão
Opción, Muelles, añade al valor de la puerta
Option, Ressorts, ajoutez à la valeur de la porte
Option, Springs, adds to value of the gate



NS.200221	Sistema para montagem de molas atrás Sistema para montaje de muelles detrás Système pour application de ressorts arrière Rear mounted springs system	+5% *
NS.200222	50 000 ciclos / cycles	+5% *
NS.200223	100 000 ciclos / cycles	+10% *

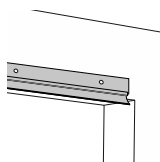

Opção, acabamento de padieira reduzida, com vedante
Opción, acabado de dintel reducido, con goma
Option, finition de linteau réduit, avec joint
Option, reduced headroom finishing, with seal

03.390611	Perfil de remate de padieira, galvanizado Perfil de acabado de dintel, galvanizado Profil de finition de linteau, galvanisé Headroom finishing profile, galvanized	€ / ml
------------------	-----------------------------------------------------------------------------------------------------------------------------------------------------------------------------	--------

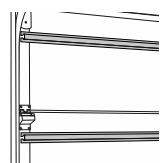

Perfil de reforço para painel, incluído na porta
Perfil de refuerzo para panel, suministrado con la puerta
Profil de renfort pour panneau, inclus dans la porte
Panel reinforcement profile, included with door

NS.522999	Perfil ómega, aço galvanizado Perfil omega, acero galvanizado Profil oméga, acier galvanisé Omega profile, galvanized steel	€ / ml *
------------------	--------------------------------------------------------------------------------------------------------------------------------------	----------

Opção, Reforço lacado branco, incluído na porta
Opción, Refuerzo lacado blanco, suministrado con la puerta
Option, Renfort laqué blanc, inclus dans la porte
Option, White powdercoated reinforcement, included with door

03.200910	Perfil ómega, lacado Perfil omega, lacado Profil oméga, laqué Omega profile, powdercoated	RAL standard € / ml *
------------------	----------------------------------------------------------------------------------------------------	-----------------------

Opção, Tensão de cabos, incluído na porta
Opción, Tensión de los cables, suministrado con la puerta
Option, Tension des câbles, inclus dans la porte
Option, Steel cables tensioning, included with door

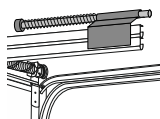

NS.200241	Amortecedor de subida Amortiguadores de subida Amortisseurs de montée Track-end spring bumpers	100mm	€ / par
NS.200242	Amortecedor de subida Amortiguadores de subida Amortisseurs de montée Track-end spring bumpers	350mm	€ / par
NS.200243	Amortecedor de subida Amortiguadores de subida Amortisseurs de montée Track-end spring bumpers	600mm	€ / par

Dobradiça de topo 70mm para calha normal
Bisagra superior 70mm para guía normal
Charnière supérieure 70mm pour rail normal
70mm top hinge for standard rail

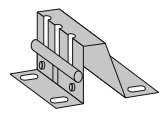

03.200101	Galvanizada Galvanizado Galvanisé Galvanized	€ / uni
03.200100	Lacado branco Lacado blanco Laqué blanc White lacquered	€ / uni

Opção
Opción
Option
Option

03.200102	Aço inox Acero inoxidable Acier inoxydable Stainless steel	€ / uni
03.200501	Alumínio bruto Aluminio bruto Aluminium brut Raw Aluminium	€ / uni
03.200500	Alumínio lacado Aluminio lacado Aluminium laqué Lacquered Aluminium	€ / uni

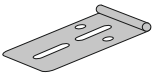
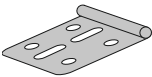
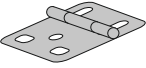
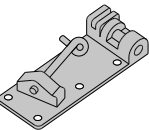
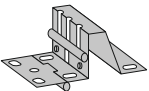
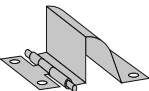
	Dobradiça de topo para calha dupla de porta industrial Bisagra superior para riel de puerta industrial doble Charnière supérieure pour double rail de porte industrielle Top hinge for double industrial door track			Opção Opción Option Option		
	03.200131	Galvanizada Galvanizado Galvanisé Galvanized	€ / uni	03.200132	Aço inox Acero inoxidable Acier inoxydable Stainless steel	€ / uni
	03.200130	Lacado branco Lacado blanco Laqué blanc White lacquered	€ / uni			
	Dobradiça de topo para calha dupla de porta residencial Bisagra superior para riel de puerta residencial doble Charnière supérieure pour double rail de porte résidentiel Top hinge for double residential door track			Opção Opción Option Option		
	03.200136	Galvanizada Galvanizado Galvanisé Galvanized	€ / uni	03.200536	Alumínio bruto Aluminio bruto Aluminium brut Raw Aluminium	€ / uni
	03.200135	Lacado branco Lacado blanco Laqué blanc White lacquered	€ / uni	03.200535	Alumínio lacado Aluminio lacado Aluminium laqué Aluminium lacquered	€ / uni
	Dobradiça central Bisagra central Charnière centrale Central hinge					
	03.509201	Galvanizada Galvanizado Galvanisé Galvanized	€ / uni			
	03.509200	Lacado branco Lacado blanco Laqué blanc White lacquered	€ / uni			
	Suporte de cabo com afinação Soporte para cables con afinación Support de câble avec réglage Cable support with tuning					
	03.200070	Alumínio bruto Aluminio bruto Aluminium brut Raw Aluminium	Par Par Paire Pair	€ / uni		
	03.200075	Alumínio lacado Aluminio lacado Aluminium laqué Aluminium lacquered	Par Par Paire Pair	€ / uni		
	Dobradiça lateral para painel anti-dedo longa Bisagra lateral para el anti-dedo largo Charnière latérale pour un long anti-fingerboard Side hinge for long anti-fingerboard			Opção Opción Option Option		
	03.200144	Galvanizada Galvanizado Galvanisé Galvanized	€ / uni	03.200145	Aço inox Acero inoxidable Acier inoxydable Stainless steel	€ / uni
	03.200143	Lacado branco Lacado blanco Laqué blanc White lacquered	€ / uni	03.200544	Alumínio bruto Aluminio bruto Aluminium brut Raw Aluminium	€ / uni
				03.200543	Alumínio lacado Aluminio lacado Aluminium laqué Aluminium lacquered	€ / uni
	Dobradiça Lateral 60mm Bisagra lateral 60mm Charnière latérale 60mm Side hinge 60mm					
	03.200044	Galvanizada Galvanizado Galvanisé Galvanized	€ / uni			
	03.200042	Lacado branco Lacado blanco Laqué blanc White lacquered	€ / uni			



Rodízio curto para ferragem simples Rodillo corto para el herraje simple Roulette courte pour le fer à repasser simple Short castor for single ironing		Opção Opción Option Option	
03.221118	Galvanizado Galvanizado Galvanisé Galvanized	€ / uni	03.221119 Aço inox Acero inoxidable Acier inoxydable Stainless steel € / uni

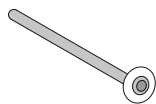

Rodízio longo para ferragem dupla Rodillo largo para el herraje doble Longue roulette pour le double repassage Long castor for double ironing		Opção Opción Option Option	
03.221193	Galvanizado Galvanizado Galvanisé Galvanized	€ / uni	03.221194 Aço inox Acero inoxidable Acier inoxydable Stainless steel € / uni

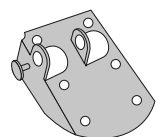

Suporte de cabo Soporte de cable Support de câble Cable holder			
03.200171	Galvanizada Galvanizado Galvanisé Galvanized	€ / uni	
03.200170	Lacado branco Lacado blanco Laqué blanc White lacquered	€ / uni	

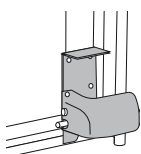

Sistema de segurança de ruptura de cabos, incluído na porta Sistema de seguridad de rotura de cables, suministrado con la puerta Système de sécurité de rupture de câble, inclus dans la porte Cable break safety device, included with door			
03.200154	Pára-queda Residencial calhas Paracaídas residencial guías Parachute résidentiel guides Residential parachute tracks	€ / par	
03.200152	Pára-queda industrial com afinação Paracaídas industrial ajustable Parachute industriel réglable Industrial parachute, adjustable	€ / par	
03.200151	Pára-queda industrial sem afinação Paracaídas industrial sin ajuste Parachute industriel sans réglage Industrial parachute without tuning	€ / par	

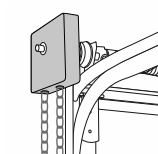
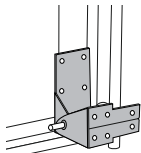

Cadernal metálico, incluído na porta Elevador de cadena, suministrado con la puerta Treuil à chaîne, inclus dans la porte Chain hoist, included with door		Acessórios para cadernal metálico Accesorios para elevador de cadena Accessoires pour treuil à chaîne Chain hoist parts	
NS.200260	Cadernal com corrente (4+4m) Elevador con cadena (4+4m) Treuil avec chaîne (4+4m) Hoist with chain (4+4m)	€ / uni	03.200261 Corrente para cadernal Cadena para elevador Chaîne pour treuil Extra chain for hoist € / ml

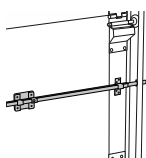

Fechadura tipo FAC, incluída na porta Cerradura tipo FAC, suministrada con la puerta Serrure type FAC, inclus dans la porte FAC lock, included with door			
NS.230330	Fechadura de segurança tipo 'FAC' Cerradura de seguridad tipo 'FAC' Serrure de sécurité type 'FAC' 'FAC' type security lock	€ / uni	

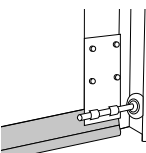

Opção, Acabamento, incluído na porta Opción, Finalización, suministrado con la puerta Option, Finition, inclus dans la porte Option, Finishing, included with door		Acessórios de acabamento Accesorios de finalización Accessoires de finition Finishing parts	
NS.502301	Perfil inferior em alumínio lacado branco Perfil inferior de aluminio lacado blanco Profil inférieur en aluminium laqué blanc Bottom aluminium profile, white powdercoated	€ / ml *	03.402191 Capa para parafuso em PVC branco Capa para tornillos de PVC blanco Protection pour vis en PVC blanc Screw caps of white PVC € / (100)
03.503310	Vedante inferior para sistema fotoelétrico Goma inferior para sistema fotoeléctrico Joint inférieur pour bord sensible Bottom seal for sensing edge	€ / ml	03.402192 Capa para parafuso em PVC preto Capa para tornillos de PVC negro Protection pour vis en PVC noir Screw caps of black PVC € / (100)

OPÇÕES E ACESSÓRIOS DE PORTA-HOMEM SECCIONADOS

OPCIONES Y RECAMBIOS PUERTA PEATONAL SECCIONALES / OPTIONS ET ACCESSOIRES PORTILLON SECTIONNELLES
OPTIONS & SPARES SECTIONAL WICKET DOOR



Fechadura para porta-homem seccionado, em kit Cerradura para puerta peatonal seccional, kit Serrure pour portillon sectionnelle, kit Lock for wicket door sectional, kit

03.230681	Kit fechadura 3 pontos Kit cerradura 3 puntos	esq. / izq. / g. / lh	€ / kit
03.230683	Kit serrure 3 points Kit 3 points	dir. / der. / dr. / rh	
03.230685	Kit fechadura 1 pontos Kit cerradura 1 puntos	esq. / izq. / g. / lh	€ / kit
03.230687	Kit serrure 1 points Kit 1 points lock	dir. / der. / dr. / rh	

Acessórios para fechadura 3 pontos porta-homem Accesorios para cerradura 3 puntos puerta peatonal Accessoires pour serrure 3 points portillon Paraphernalia for wicket door 3 points lock

03.230389	Kit 3 canhões e 6 chaves (3 pontos) Kit 3 bombillos y 6 llaves (3 puntos) Kit 3 cylindres et 6 clés (3 points) Kit 3 cylinders and 6 keys (3 points)	€ / kit
03.230999	Chave extra (canhão de 6 pinos) Llave extra (bombillo de 6 pines) Clé extra (serrure à 6 goupilles) Extra key (6 pin cylinder)	€ / kit

Opção, Segurança Opción, Seguridad Option, Sécurité Option, Safety

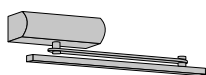

11.100043	Mola de fecho com braço deslizante Cierrapuertas de guía deslizante Ferme-porte avec bras glissière Door closer with slide channel	€ / kit
03.230602	Kit porta homem, fechadura 3P univ. branco Kit puerta hombre, cerradura 3P univ. blanco Kit porte homme, serrure 3P universel blanc Universal wicket door lock kit 3P white	preço sob consulta precio a petición prix sur demande price upon request

OPÇÕES E ACESSÓRIOS PORTA DE SERVIÇO LATERAL

OPCIONES Y RECAMBIOS PUERTA PEATONAL LATERAL / OPTIONS ET ACCESSOIRES PORTE PIÉTONNE LATÉRALE
OPTIONS & SPARES PEDESTRIAN LATERAL DOOR

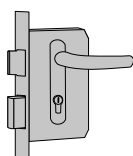

Fechadura para porta de serviço lateral Cerradura para puerta peatonal lateral Serrure pour porte piétonne latéral Lock for pedestrian lateral door

03.506922	Fechadura 1 ponto Cerradura 1 punto Serrure 1 point 1 point lock	€ / uni
------------------	---------------------------------------------------------------------------	---------

Acessórios para fechadura porta de serviço Accesorios para cerradura puerta peatonal lateral Accessoires pour serrure porte piétonne lateral Locks paraphernalia for pedestrian lateral door

03.230390	Trinco eléctrico 12V Pestillo eléctrico 12V Gâche électrique 12V Electric latch 12V	€ / uni
03.230353	Canhão 35/25 e 3 chaves Bombillo 30/30 y 3 llaves Cylindre 30/30 et 3 clés Cylinder 30/30 and 3 keys	€ / kit
03.230343	Chave extra (canhão de 5 pinos) Llave extra (bombillo de 5 pines) Clé extra (serrure à 5 goupilles) Extra key (5 pin cylinder)	€ / uni

Fechadura para porta de serviço lateral Cerradura para puerta peatonal lateral Serrure pour porte piétonne latéral Lock for pedestrian lateral door

03.506923	Fechadura 3 pontos Cerradura 3 puntos Serrure 3 points 3 points lock	€ / uni
------------------	-------------------------------------------------------------------------------	---------

OMBREIRAS FALSAS

PREMARCOS / FAUX ÉCOINÇONS / JAMB POSTS

Ombreira em tubo de ferro decapado, incluída na porta Premarco de tubo de hierro decapado, suministrada con la puerta Écoiçon en tube de fer brut, inclus dans la porte Jamb post of raw iron profile, included with door

NS.201002	Ombreira falsa Premarco Faux écoiçons Jamb post	80x40x1,5mm	€ / ml
NS.201102	Ombreira falsa Premarco Faux écoiçons Jamb post	100x40x2mm	€ / ml
NS.201112	Ombreira falsa Premarco Faux écoiçons Jamb post	100x100x3mm	€ / ml

Ombreira em tubo de ferro lacado RAL, incluída na porta Premarco de tubo de hierro lacado RAL, suministrada con la puerta Écoiçon en tube de fer laqué RAL, inclus dans la porte Jamb post of iron profile powdercoated RAL, included with door

NS.201400	Ombreira falsa Premarco Faux écoiçons Jamb post	40x40x2mm	€ / ml
NS.201300	Ombreira falsa Premarco Faux écoiçons Jamb post	60x40x2mm	€ / ml
NS.201000	Ombreira falsa Premarco Faux écoiçons Jamb post	80x40x1,5mm	€ / ml

Ombreira em tubo de ferro lacado branco, incluída na porta Premarco de tubo de hierro lacado blanco, suministrada con la puerta Écoiçon en tube de fer laqué blanc, inclus dans la porte Jamb post of white coated iron profile, included with door

NS.201001	Ombreira falsa Premarco Faux écoiçons Jamb post	80x40x1,5mm	€ / ml
NS.201101	Ombreira falsa Premarco Faux écoiçons Jamb post	100x40x2mm	€ / ml
NS.201111	Ombreira falsa Premarco Faux écoiçons Jamb post	100x100x3mm	€ / ml

Ombreira em tubo de ferro lacado branco, incluída na porta Premarco de tubo de hierro lacado blanco, suministrada con la puerta Écoiçon en tube de fer laqué blanc, inclus dans la porte Jamb post of white coated iron profile, included with door

NS.201100	Ombreira falsa Premarco Faux écoiçons Jamb post	100x40x2mm	€ / ml
NS.201110	Ombreira falsa Premarco Faux écoiçons Jamb post	100x100x3mm	€ / ml
NS.201142	Ombreira falsa Premarco Faux écoiçons Jamb post	120x100x3mm	€ / ml
NS.201201	Ombreira falsa Premarco Faux écoiçons Jamb post	160x60x2mm	€ / ml
NS.201200	Ombreira falsa Premarco Faux écoiçons Jamb post	200x40x2mm	€ / ml

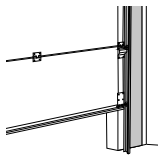

Opção Ombreiras de ferro, incluído na porta Opción Premarcos de hierro, suministrado con la puerta Option Écoiçons de fer, inclus dans la porte Option Iron jamb posts, included with door

NS.201999	Patilhas de fixação montadas Pestañas de fijación montadas Pâtes de fixation montées Mounted fixation plates		€/kit *
------------------	-----------------------------------------------------------------------------------------------------------------------	--	---------

Opção Ombreiras de ferro, incluído na porta Opción Premarcos de hierro, suministrado con la puerta Option Écoiçons de fer, inclus dans la porte Option Iron jamb posts, included with door

03.201190	Patilha de fixação, encaixe 100x40mm, galvanizada Pestaña de fijación, encaje 100x40mm, galvanizada Patte de fixation, raccord 100x40mm, zingué Fastening clamp, fitting 100x40mm, galvanised		€/uni.*
03.201090	Patilha de fixação, encaixe 80x40mm, galvanizada Pestaña de fijación, encaje 80x40mm, galvanizada Patte de fixation, raccord 80x40mm, zingué Fastening clamp, fitting 80x40mm, galvanised		€/uni.*

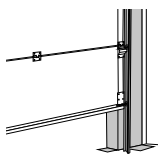

Ombreira em tubo de alumínio lacado, incluída na porta Premarco de tubo de aluminio lacado, suministrada con la puerta Écoiçon en tube de aluminium laqué, inclus dans la porte Jamb post of powdercoated aluminium profile, included with door

NS.202001	Ombreira falsa, branco Premarco, blanco Faux écoiçons, blanc Jamb post, white	80x40x1,5mm	€/ml
NS.202101	Ombreira falsa, branco Premarco, blanco Faux écoiçons, blanc Jamb post, white	100x40x1,5mm	€/ml

Ombreira em tubo de alumínio lacado a imitação de madeira Premarco de tubo de aluminio lacado a imitación de madera Écoiçon en tube de aluminium laqué a imitation bois Jamb post aluminium profile, powdercoated in timber design

NS.202056	Madeira clara Madera clara Bois clair Light timber	80x40x5000mm	sob consulta
NS.202066	Madeira escura Madera oscura Bois foncé Dark timber	80x40x6500mm	sob consulta

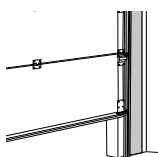

PADIEIRAS FALSAS

DINTELES FALSOS / FAUX LINTEAUX / LINTEL FASCIAS

- As padieiras falsas são terminadas com perfil 'U', inferior, pintado à cor do painel escolhido. Faturação mínima: 1m²
- Los dinteles falsos tienen remate de perfil 'U', inferior, pintado en el color del panel elegido. Facturación mínima: 1m²
- Les faux linteaux sont terminé avec profile 'U', inférieur, peint à la couleur du panneau choisi. Minimum de facturation: 1m²
- Lintel fascias are included with a bottom 'U' profile, painted in the colour of the chosen panel. Minimum charge: 1m²

Padieira em painel Canelado Woodgrain, incluída na porta Dintel de panel Acanalado Woodgrain, suministrado con la puerta Linteau en panneau Rainuré Woodgrain, inclus dans la porte Fascia of Ribbed Woodgrain panel, included with door

PD.040CA00	Branco Blanco Blanc White	RAL 9010	€/ m ² *	PD.040CA02	Castanho Marrón Marron Brown	RAL 8014	€/ m ² *
PD.040CA06	Crema Crema Beige Cream	RAL 1015	€/ m ² *	PD.040CA08	Azul Azul Bleu Blue	RAL 5010	€/ m ² *
PD.040CA07 PD.040CA15 PD.040CA11 PD.040CA12	Cinza Gris Gris Grey	RAL 9006 RAL 9007 RAL 7011 RAL 7016	€/ m ² *	PD.040CA09	Vermelho Rojo Rouge Red	RAL 3000	€/ m ² *
PD.040CA01 PD.040CA10	Verde Verde Vert Green	RAL 6005 RAL 6009	€/ m ² *	PD.040CA18	Preto Negro Noir Black	RAL 9005	€/ m ² *

Opção, Acabamento pintado Opción, Acabado pintado Option, Finition peint Option, Painted finishing

PD.040CA99	Catálogo RAL (1 face) Carta RAL (1 cara) Nuancier RAL (1 face) RAL colour chart (1 side)	€/ m ² *	PD.040CA98	Afinação por amostra (1 face) Afinación por muestra (1 cara) Afination par échantillon (1 face) Sampled colour (1 side)	€/ m ² *
-------------------	---------------------------------------------------------------------------------------------------	---------------------	-------------------	----------------------------------------------------------------------------------------------------------------------------------	---------------------

Padieira em painel Canelado Alumínio, incluída na porta Dintel de panel Acanalado Aluminio, suministrado con la puerta Linteau en panneau Rainuré Aluminium, inclus dans la porte Fascia of Ribbed Aluminium panel, included with door

PD.040CAA0	Branco Blanco Blanc White	RAL 9030	€/ m ² *	PD.040CAA9	Catálogo RAL (1 face) Carta RAL (1 cara) Nuancier RAL (1 face) RAL colour chart (1 side)	€/ m ² *
PD.040CAA1	Branco Blanco Blanc White	RAL 9030	€/ m ² *	PD.040CAA8	Afinação por amostra (1 face) Afinación por muestra (1 cara) Afination par échantillon (1 face) Sampled colour (1 side)	€/ m ² *

Padieira em painel Canelado Liso lacado, incluída na porta Dintel de panel Acanalado Liso lacado, suministrado con la puerta Linteau en panneau Rainuré Lisse laqué, inclus dans la porte Fascia of Ribbed Super Flat panel powdercoated, included with door

PD.040CA13 PD.040CA14	Imitação de madeira clara/escuro Imitación de madera clara/oscura Imitation bois clair/foncé Light/Dark timber coated design	€/ m ² *	PD.040CA73 PD.040CA74	Imitação de madeira clara/escuro, 2 faces Imitación de madera clara/oscura, 2 caras Imitation bois clair/foncé, 2 faces 2-sided light/dark timber coated design	€/ m ² *
----------------------------------------	---------------------------------------------------------------------------------------------------------------------------------------	---------------------	----------------------------------------	--------------------------------------------------------------------------------------------------------------------------------------------------------------------------	---------------------

Padieira em painel Friso Único Woodgrain, incluída na porta Dintel de panel Unicanalado Woodgrain, suministrado con la puerta Linteau en panneau Mono Ligne Woodgrain, inclus dans la porte Fascia of Centre Ribbed Woodgrain panel, included with door

PD.040CA40	Branco Blanco Blanc White	RAL 9010	€/ m ² *	PD.040CA49	Catálogo RAL (1 face) Carta RAL (1 cara) Nuancier RAL (1 face) RAL colour chart (1 side)	€/ m ² *
PD.040CA82	Cinza Gris Gris Grey	RAL7016	€/ m ² *	PD.040CA48	Afinação por amostra (1 face) Afinación por muestra (1 cara) Afination par échantillon (1 face) Sampled colour (1 side)	€/ m ² *

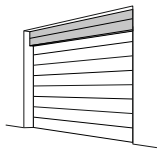

Padieira em painel Friso Único Liso incluída na porta
Dintel de panel Unicanalado Liso, suministrado con la puerta
Lintheau en panneau Mono Ligne Lisse, inclus dans la porte
Fascia of Centre Ribbed Super Flat panel, included with door

PD.040CA30	Branco Blanco Blanc White	RAL 9010	€/ m ² *
PD.040CA33 PD.040CA34	Imitação de madeira clara/escuro Imitación de madera clara/oscura Imitation bois clair/foncé Light/Dark timber coated design		€/ m ² *

Opção, Acabamento pintado
Opción, Acabado pintado
Option, Finition peint
Option, Painted finishing

PD.040CA79	Catálogo RAL (1 face) Carta RAL (1 cara) Nuancier RAL (1 face) RAL colour chart (1 side)	€/ m ² *
PD.040CA78	Afinação por amostra (1 face) Afinación por muestra (1 cara) Afination par échantillon (1 face) Sampled colour (1 side)	€/ m ² *

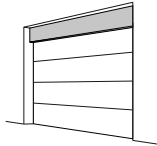

Padieira em painel Micro-friso, incluída na porta
Dintel de panel Microacanalado, suministrado con la puerta
Lintheau en panneau Micronervuré, inclus dans la porte
Fascia of Micro ribbed panel, included with door

PD.040CA00	Branco Blanco Blanc White	RAL 9010	€/ m ² *
-------------------	------------------------------------	----------	---------------------

Opção, Acabamento pintado
Opción, Acabado pintado
Option, Finition peint
Option, Painted finishing

PD.040CA99	Catálogo RAL (1 face) Carta RAL (1 cara) Nuancier RAL (1 face) RAL colour chart (1 side)	€/ m ² *
PD.040CA98	Catálogo RAL (1 face) Carta RAL (1 cara) Nuancier RAL (1 face) RAL colour chart (1 side)	€/ m ² *

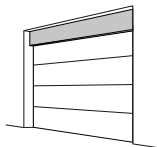

Padieira em painel Liso Liso, incluída na porta
Dintel de panel Liso Liso, suministrado con la puerta
Lintheau en panneau Lisse Lisse, inclus dans la porte
Fascia of Super flat panel, included with door

PD.040CA20	Branco Blanco Blanc White	RAL 9010	€/ m ² *
PD.040CA23 PD.040CA24	Imitação de madeira clara/escuro Imitación de madera clara/oscura Imitation bois clair/foncé Light/Dark timber coated design		€/ m ² *

Opção, Acabamento pintado
Opción, Acabado pintado
Option, Finition peint
Option, Painted finishing

PD.040CA89	Catálogo RAL (1 face) Carta RAL (1 cara) Nuancier RAL (1 face) RAL colour chart (1 side)	€/ m ² *
PD.040CA88	Afinação por amostra (1 face) Afinación por muestra (1 cara) Afination par échantillon (1 face) Sampled colour (1 side)	€/ m ² *

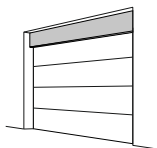

Padieira em painel sablé
Dintel de panel sablé
Lintheau en panneau sablé
Countertop in sablé

PD.040CA29	Painel blanc Panel blanc Panneau blanc Sablé blanc	€/ m ² *
-------------------	-------------------------------------------------------------	---------------------

Padieira em painel corten
Dintel de panel corten
Lintheau en panneau corten
Countertop in corten

PD.040CA93	Painel corten Panel corten Panneau corten Corten panel	Imitação de aço corten Imitación de acero corten Imitation acier corten Corten steel imitation	€/ m ² *
-------------------	-----------------------------------------------------------------	---------------------------------------------------------------------------------------------------------	---------------------

PD.040CA28	Painel sablé noir Panel sablé noir Panneau sablé noir Sablé panel noir	€/ m ² *
-------------------	---------------------------------------------------------------------------------	---------------------

Padieira em painel silver
Dintel de panel silver
Lintheau en panneau silver
Countertop in silver

PD.040CA25	Painel sablé Panel sablé Panneau sablé Sablé panel	€/ m ² *
PD.040CA91	Painel silver Panel silver Panneau silver Silver panel	€/ m ² *

Padieira em painel inox
Dintel de panel corten
Lintheau en panneau corten
Countertop in corten

PD.040CA94	Painel inox Panel inox Panneau inox Inox panel	Imitação inox escovado Imitación de acero inoxidable cepillado Imitation acier inoxydable brossé Brushed stainless steel imitation	€/ m ² *
-------------------	---------------------------------------------------------	---------------------------------------------------------------------------------------------------------------------------------------------	---------------------



Perfil de padieira de alumínio em U
Perfil para dintel de aluminio en forma de U
Rail pour lintheau en aluminium en forme de U
U-shaped aluminium lintel rail

03.501309	Perfil de alumínio em U RAL Perfil de aluminio en forma de U RAL Rail en aluminium en forme de U RAL U-shaped aluminium rail RAL	€/ ml
------------------	-------------------------------------------------------------------------------------------------------------------------------------------	-------

MAX. 5X3m

MIN. 80mm

PADIEIRA / DINTEL / LINTEAU / HEADROOM

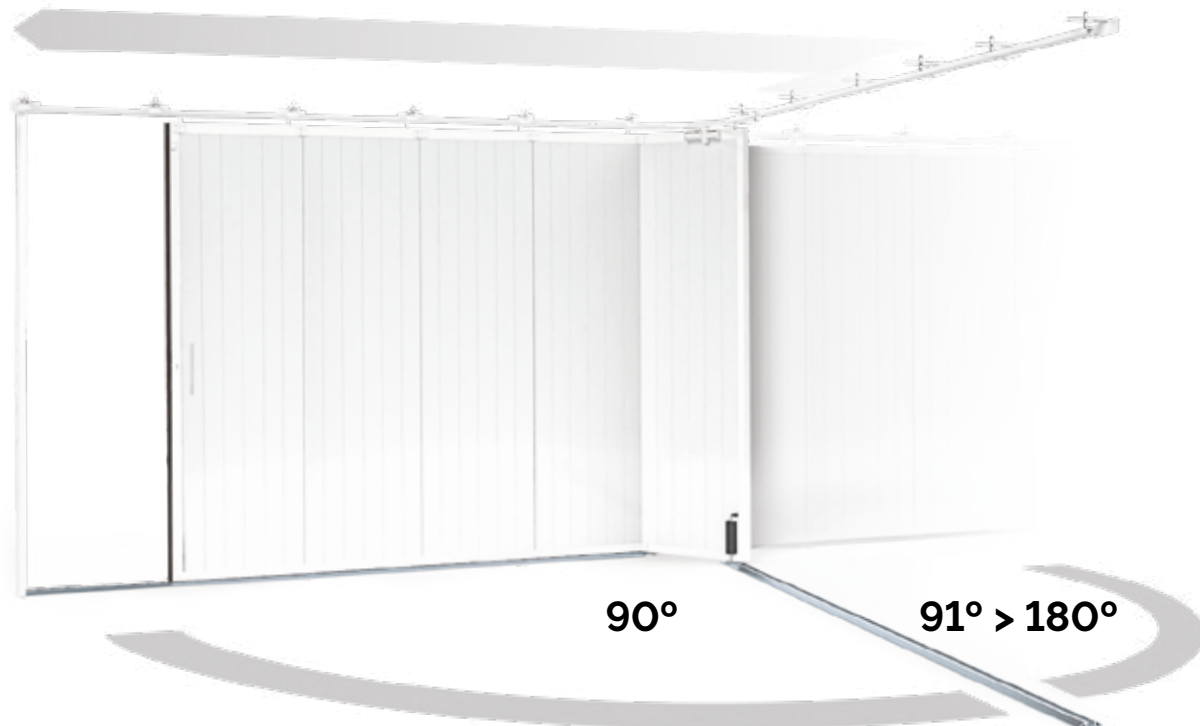

MIN. 150mm

OMBREIRA / MARCO / ÉCOINÇON / JAMB

01

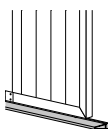

- Guia inferior de rampa dupla, em alumínio extrudido
- Guía inferior en rampa doble, de aluminio extrudido
- Guide inférieur à double rampe, en aluminium extrudé
- Double ramp floor track, of extruded aluminium

02

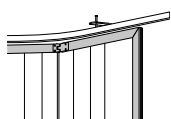

- Perfil de alumínio reforçado, termo-lacado e pintado à cor do painel, em todo o perímetro da porta
- Perfil de aluminio reforzado, perimetral, termolacado y pintado en el color del panel
- Profil en aluminium renforcé, thermo-laqué et peint à la couleur du panneau, autour du périmètre de la porte
- Reenforced aluminium profile, powdercoated and painted with the panels colour, all edges

03

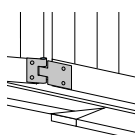

- Dobradiças centrais em aço galvanizado com ponto de lubrificação
- Bisagras intermedias de acero galvanizado con ojet de lubricación
- Charnières centrales en acier galvanisé et point de lubrification
- Central hinges of galvanized steel with lubrication point

04

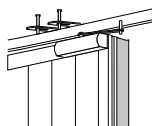

- Vedante traseiro em EPDM preto e mola de fecho montada no último painel, para um fecho seguro e maior estanquidade
- Goma trasera de EPDM negro y cierrapuertas acoplado en el último panel, para mejor estanquidad y seguridad cuando cerrada
- Joint d'étanchéité arrière en EPDM noir et ferme-porte posé sur le dernier panneau, pour une meilleure étanchéité et sécurité de la fermeture
- Back seal of black EPDM and doorcloser over the end panel, for best tightness and closing

05

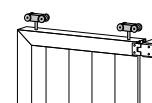

- Carrinhos em aço galvanizado com rodas em nylon, para um movimento silencioso na guia superior
- Soportes rodantes de acero galvanizado con ruedas de nylon, para un desplazamiento silencioso en la guía superior
- Chariots en acier galvanisé avec roulettes en nylon, pour un mouvement silencieux du guide supérieur
- Galvanized steel hangers with silent running nylon wheels

06

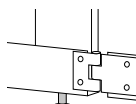

- Guiamento na guia inferior por rolamentos de esferas em aço
- Guiadores inferiores con rodamientos de bolas en acero
- Guide vertical et rails en acier galvanisé
- Floor track guiders with steel ball bearings

07

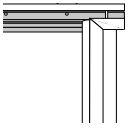

- Vedante superior em PVC vulcanizado preto, montado em suporte na padieira
- Goma superior de PVC vulcanizado negro, montado en soporte en el dintel
- Joints supérieurs en PVC vulcanisé noir, posé sur support dans le linteau
- Top seal of vulcanized black PVC, applied in support over headroom

08

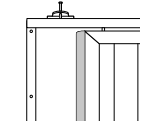

- Vedante frontal longo em EPDM preto, com batente em aço galvanizado
- Goma frontal largo de EPDM negro, con batiente de acero galvanizado
- Joint d'étanchité frontal long en EPDM noir et battant en acier galvanisé
- Front seal of black EPDM with door stopper of galvanized steel

09

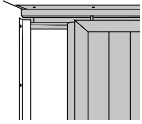

- Batente de vedante frontal em aço galvanizado, lacado e pintado à cor do painel
- Batiente de goma frontal, de acero galvanizado, lacado y pintado a la color del panel
- Battant de joint d'étanchité frontal, en acier galvanisé, laqué et peint à la couleur du panneau
- Front seal door stopper, of galvanized steel, powdercoated and painted same as panel colour/joint

10

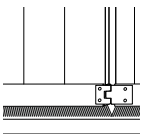

- Vedante inferior de escova em polipropileno
- Goma inferior de escobilla de polipropileno
- Joint brosse inférieur en polypropylène
- Bottom brush seal of polypropylene

11

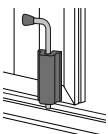

- Trinco traseiro em aço galvanizado com veio redondo maciço
- Cerrojo de acero galvanizado con eje redondo macizo
- Verrou arrière en acier galvanisé avec un axe massif
- Solid round bar floor bolt, galvanized steel

12

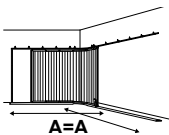

- Profundidade mínima do local de aplicação igual à largura do vão
- Profundidad mínima del espacio de instalación igual al ancho del hueco
- Refoulement minimum doit être égal à la largeur entre baie
- Minimum depth of installation site must be the same as the opening width

13

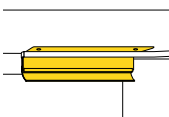

- Guia superior em suporte 'L', em aço galvanizado, aplicada directamente ao tecto
- Guía superior en soporte 'L', de acero galvanizado, para montaje directo en el techo
- Guide supérieur sur support 'L', en acier galvanisé, pour appliée directement sur plafond
- Top track on 'L' support, of galvanized steel, directly applied to ceiling

14

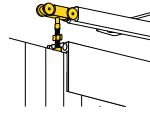

- Afição directamente no veio do carrinho
- Afinación directa por el eje del soporte rodante
- Réglage directement sur l'axe du charriot
- Tuning of the door directly over hangers axle

15

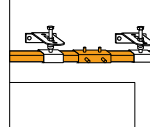

- Guia superior repartida com suportes e uniões, em aço galvanizado
- Guia superior repartida y con acoplamientos, de acero galvanizado
- Guide supérieur réparti et avec des unions, en acier galvanisé
- Top track splitted and with couplers, of galvanized steel

16

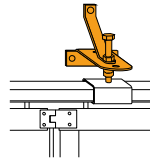

- Suportes de guia superior com afinação total, em aço galvanizado
- Soportes de guía superior con afinación total, de acero galvanizado
- Supports du guide supérieur totalment réglables, en acier galvanisé
- Top track brackets with full tuning, of galvanized steel

17

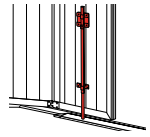

- Fechadura de segurança tipo 'FAC' em aço galvanizado
- Cerradura de seguridad tipo 'FAC', de acero galvanizado
- Serrure de sécurité type 'FAC' en acier galvanisé
- 'FAC' type security lock of galvanized steel

18

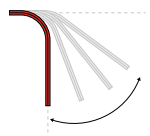

- Curvatura da guia superior e esquadria da guia inferior feitas por medida (sem stock)
- Curvatura de la guía superior y esquadria de la guía inferior hechas por pedido (sin stock)
- Courbure du rail supérieur et équerrage du rail inférieur exécuté sur mesure (sans stock)
- Curvature of top track and frame cut of floor track only by order (no stock)

19

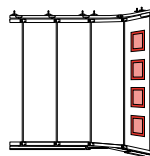

- Janelas em vidro, visores em policarbonato e ventiladores em alumínio e PVC
- Mirillas de vidrio o policarbonato y ventiladores de aluminio o PVC
- Hublots de verre ou polycarbonate et grilles de ventilation en aluminium et PVC
- Glass or polycarbonate windows and ventilation grids of aluminium or PVC

20

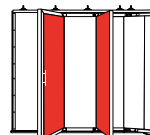

- Porta-homem embutida no portão
- Puerta peatonal insertada en el portón
- Portillon encastré dans la porte
- Built-in wicket door

CONFIGURAÇÃO DE MOTORIZAÇÃO / ECLIPSE

CONFIGURACIONES DE MOTORIZACIÓN ECLIPSE / CONFIGURATIONS DE MOTORISATION ECLIPSE
AUTOMATED DOOR CONFIGURATION ECLIPSE

- Motorização com motor de arrasto, de alta sensibilidade a quaisquer obstáculos
- Motorización con motor de techo, con gran sensibilidad a cualesquier obstáculos
- Motorisation avec moteur tirant, de haute sensibilité à tous les obstacles
- Automated with ceiling operator, high level of sensitivity to obstacles

TIPO 1

TIPO 1 / TYPE 1 / TYPE 1

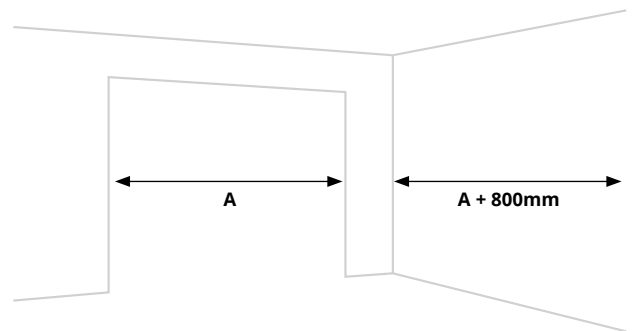
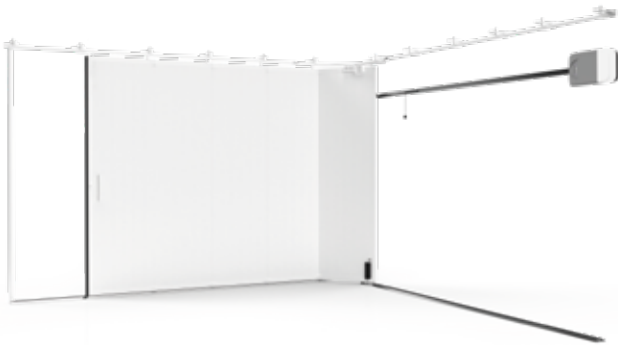

TIPO 2

TIPO 2 / TYPE 2 / TYPE 2

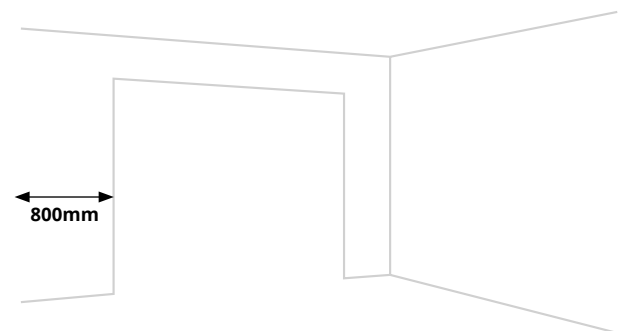
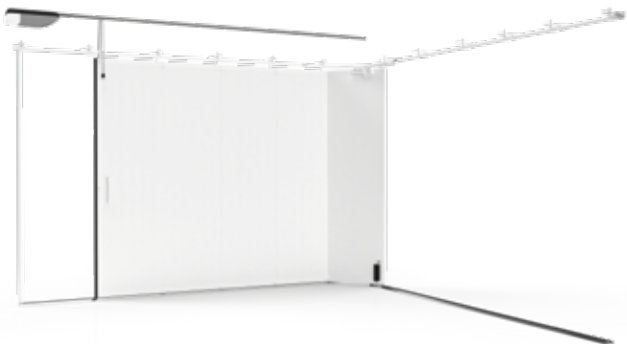

TIPO 3

TIPO 3 / TYPE 3 / TYPE 3

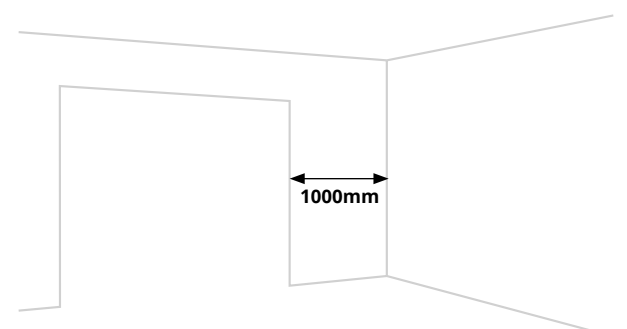
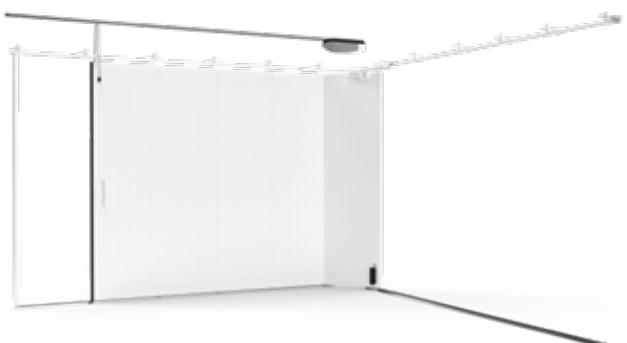

OPÇÕES E ACESSÓRIOS / ECLIPSE

OPCIONES Y ACCESORIOS PARA PUERTAS ECLIPSE / OPTIONS ET ACCESSOIRES POUR PORTES ECLIPSE
ECLIPSE DOOR OPTIONS AND ACCESSORIES

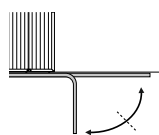

Calha superior em aço galvanizado, incluída na porta
Guía superior de acero galvanizado, suministrada con la puerta
Rail supérieur en acier galvanisé, inclus dans la porte
Top track of galvanized steel, included in the door

PL.900010 Calha com curvatura entre 91° e 179°
Guía con curvatura de 91° hasta 179°
Rail avec courbure de 91° jusqu'à 179°
Track curved from 91° to 179° € / uni *

Opção, Calhas e ferragem
Opción, Guías y herraje
Option, Rails et ferrures
Option, Tracks and hardware

NS.GL Calha superior lacada, aço galvanizado
Guía superior lacada, acero galvanizado
Rail supérieur laqué, acier galvanisé
Powdercoated top track, galvanized steel € / uni *

NS.FL Ferragem lacada, aço galvanizado
Herraje lacado, acero galvanizado
Ferrures laqués, acier galvanisé
Powdercoated hardware, galvanized steel € / uni *

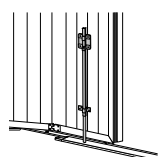

Fechadura tipo 'FAC', incluída na porta Eclipse
Cerradura de seguridad tipo 'FAC', suministrada con la puerta Eclipse
Serrure de sécurité type 'FAC', inclus dans la porte Eclipse
'FAC' type security lock, included in the Eclipse door

NS.230330 Fechadura de segurança tipo 'FAC' / Eclipse
Cerradura de seguridad tipo 'FAC' / Eclipse
Serrure de sécurité type 'FAC' / Eclipse
'FAC' type security lock / Eclipse € / uni

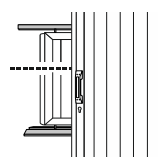

Fechadura 2 pontos vertical
Cerradura 2 puntos vertical
Serrure 2 points vertical
Top and bottom vertical lock

03.509400 Fechadura vertical com canhão europeu
Cerradura vertical com bombillo europeo
Serrure vertical avec cylindre européen
Vertical lock with europrofile cylinder € / uni

Acessórios para fechaduras
Accesorios para cerraduras
Accessoires pour serrures
Locks paraphernalia

03.230343 Canhão 30/30 e 3 chaves
Bombillo 30/30 y 3 llaves
Cylindre 30/30 et 3 clés
Cylinder 30/30 and 3 keys € / kit

03.230999 Chave extra (fechadura de 6 pinos)
Llave extra (cerradura de 6 pines)
Clé extra (serrure à 6 goupilles)
Extra key (6 pin lock) € / uni

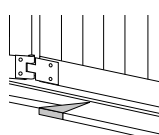

Terminais de acabamento de guia de chão, em PVC preto
Topes de finalización de guía del suelo, de PVC negro
Montants de finition de guide de sol, en PVC noir
Floor's rail end tops, of black PVC

03.509197 Terminal esquerdo de guia
Tope izquierdo de la guía
Montant gauche de guide
Rail's top end, left-hand € / uni

03.509198 Terminal direito de guia
Tope derecho del macho
Montant droit de guide
Rail's top end, right-hand € / uni

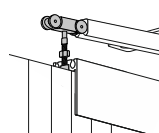

Guiamento superior da porta
Guiamiento superior de la puerta
Guidage supérieur de la porte
Door's hang running

03.509102 Carrinho superior com veio
Soporte rodante con eje
Chariot avec arbre
Hanger with axle € / uni

Guiamento superior + inferior da porta
Guiamiento superior + inferior de la puerta
Guidage supérieur + inférieur de la porte
Door's hang running and bottom guidance

03.509110 Carrinho superior + guiador inferior
Soporte rodante + guiador inferior
Chariot + guidon inférieur
Hanger + bottom guider € / kit

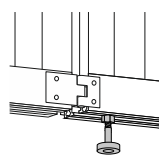

Guiamento inferior da porta
Guiamiento inferior de la puerta
Guidage inférieur de la porte
Door's bottom guidance

03.509117 Guiador inferior com veio
Guiador inferior con eje
Guidon inférieur avec arbre
Bottom guider with axle € / uni

* Artigo não sujeito a desconto / Precio neto / Article sans remise / Article not subject to discount

LUSO 40 / 80

PAINEL / PANEL / PANNEAU / PANEL



TEXTURAS

TEXTURA / TEXTURE / TEXTURE

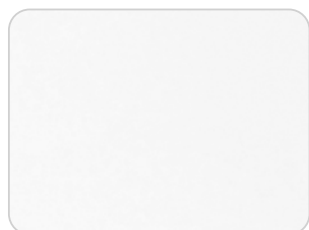

- Lisa
- Lisa
- Lisse
- Smooth

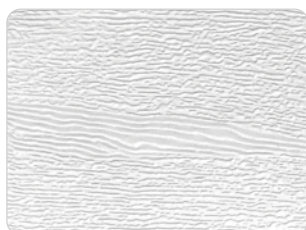

- Woodgrain



- Stucco

FRISOS

FRISOS / RAINURE / PANNEL RIB

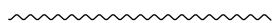

- Micro-Friso
- Microacanelado
- Micronervuré Lisse
- Micro Ribbed Flat

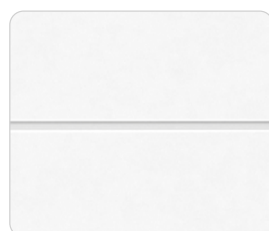

- Friso Único
- Unicanalado
- Mono Ligne
- Centre Ribbed

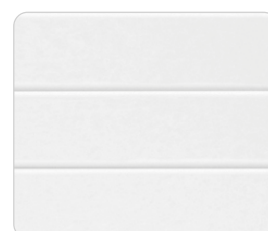
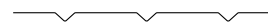

- Canelado
- Acanalado
- Rainuré
- Ribbed

LUSO 40

PAINEL / PANEL / PANNEAU / PANEL

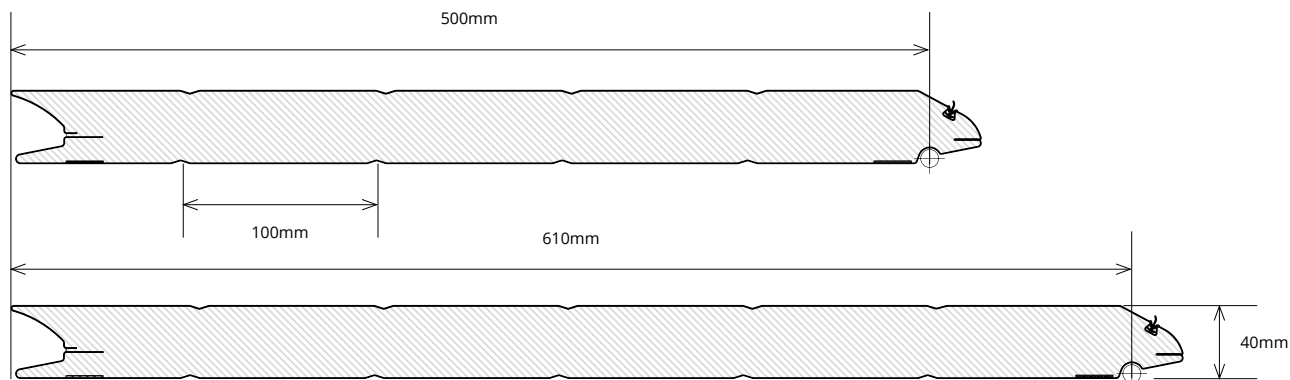

LUSO 80

PAINEL / PANEL / PANNEAU / PANEL

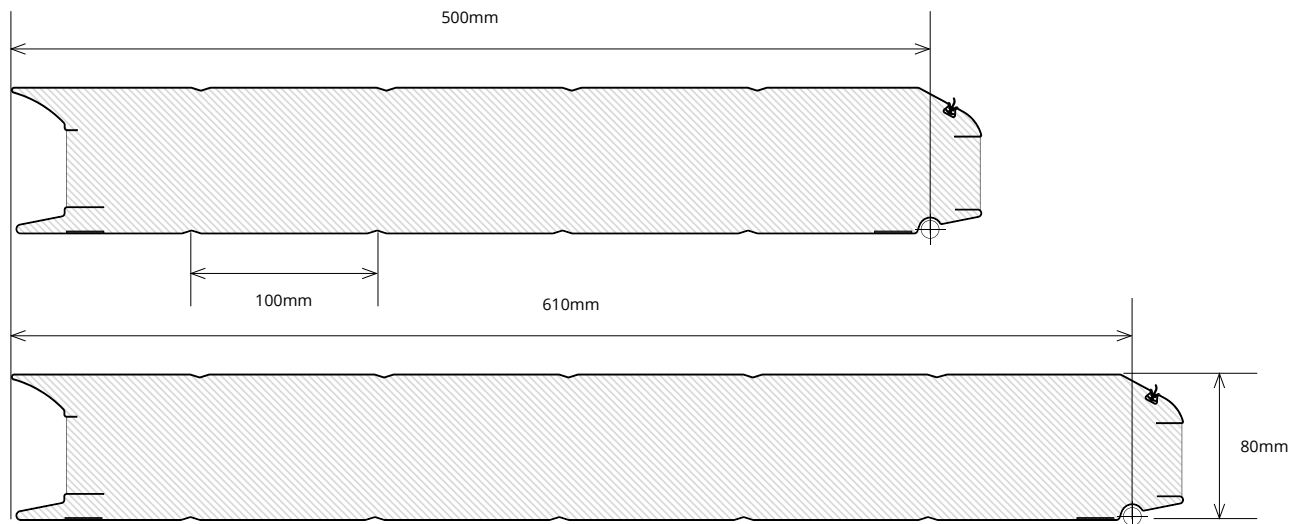

Isolamento do painel Aislamiento del panel Isolation des panneau Panel insulation









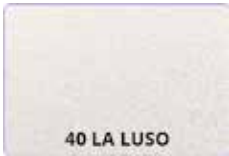

	Luso 40	Luso 80
Densidade Densidad Densité Density	± 45 Kg/m ³	± 39,14 kg/m ³
Força de aderência Fuerza de agarre Force de préhension Adhesive strength	± 0.15 MPa	± 0.14 MPa
Resistência á compressão Resistencia a la compresión Résistance à la compression Resistance to compression	± 0.13 MPa	± 3.15 MPa
Módulo de elasticidade em compressão Módulo de elasticidad en compresión Module d'élasticité en compression Modulus of elasticity in compression	± 2.68 MPa	± 3.73 MPa
Condutividade térmica Conductividad térmica Conductivité thermique Thermal conductivity	± 0.14 W/mk	± 0.03 W/mk
Índice de células fechadas Índice de células cerradas Indice de cellules fermées Closed cell index	± 94%	± 94%

Chapa de aço do painel luso Chapa de acero del panel luso Feuille d'acier du panneau luso Luso panel steel plate

- Painel em poliuretano expandido com espessura de 40/80mm
Aço estrutural do tipo DX51+Z laminado a frio
- Galvanização por imersão a quente
- Panel de poliuretano expandido con un grosor de 40/80 mm
Acero estructural tipo DX51+Z laminado en frío
- Galvanización por inmersión en caliente
- Panneau en polyuréthane expansé d'une épaisseur de 40/80 mm
Acier de construction de type DX51+Z laminé à froid
- Galvanisation par immersion à chaud
- Expanded polyurethane panel with a thickness of 40/80 mm
DX51+Z cold-rolled structural steel
- Hot-dip galvanisation

CORES E TEXTURAS

PANEL LUSO / PANNEAU LUSO / PANEL LUSO

					
	LM Sablé Blanc	LM Sablé Noir	LM Sablé	LM Silver	LM Inox
Ref. Luso 500	53.500229	53.500228	53.500225	53.500291	53.500294
Ref. Luso 610	53.610229	53.610228	53.610225	53.610291	53.610294
Cara exterior Cara exterior Coté extérieur Outer side	Textura lisa aço Textura lisa acero Texture lisse acier Fine Texture steel	Textura lisa aço Textura lisa acero Texture lisse acier Fine Texture steel	Textura lisa aço Textura lisa acero Texture lisse acier Fine Texture steel	Textura lisa aço Textura lisa acero Texture lisse acier Fine Texture steel	Textura lisa aço Textura lisa acero Texture lisse acier Fine Texture steel
Cor exterior Color exterior Couleur extérieur Colour outer side	RAL 9016	RAL 9005	RAL 7016	Similar Ral. 9006 Similar Ral. 9006 Similaire Ral. 9006 Similar Ral. 9006	Imitação inox escovado Imitatione de inox cepillado Imitation acier inox brossé Brushed stainless steel imitation
Cara interior Cara interior Coté intérieur Inner side	Canelado stucco aço Acanalado stucco acero Rainuré stucco acier Ribbed stucco steel	Canelado stucco aço Acanalado stucco acero Rainuré stucco acier Ribbed stucco steel	Canelado stucco aço Acanalado stucco acero Rainuré stucco acier Ribbed stucco steel	Canelado stucco aço Acanalado stucco acero Rainuré stucco acier Ribbed stucco steel	Canelado stucco aço Acanalado stucco acero Rainuré stucco acier Ribbed stucco steel
Cor interior Color interior Couleur intérieur Colour inner side	RAL 9010	RAL 9010	RAL 9010	RAL 9010	RAL 9010
Preço Luso 500 Precio Luso 500 Prix Luso 500 Price Luso 500	€/ ml	€/ ml	€/ ml	€/ ml	€/ ml
Preço Luso 610 Precio Luso 610 Prix Luso 610 Price Luso 610	€/ ml	€/ ml	€/ ml	€/ ml	€/ ml
					
	LM Corten	LM Liso Liso LM Liso Liso LM Lisse Lisse LM Super Flat	LM Liso Liso LM Liso Liso LM Lisse Lisse LM Super Flat	LM Liso Liso LM Liso Liso LM Lisse Lisse LM Super Flat	LM Liso Liso LM Liso Liso LM Lisse Lisse LM Super Flat
Ref. Luso 500	53.500293	53.500220	53.500222	53.500224	53.500223
Ref. Luso 610	53.610293	53.610220	53.610222	53.610224	53.610223
Cara exterior Cara exterior Coté extérieur Outer side	Textura lisa aço Textura lisa acero Texture lisse acier Fine Texture steel	Textura lisa aço Textura lisa acero Texture lisse acier Fine Texture steel	Textura lisa aço Textura lisa acero Texture lisse acier Fine Texture steel	Textura lisa aço Textura lisa acero Texture lisse acier Fine Texture steel	Textura lisa aço Textura lisa acero Texture lisse acier Fine Texture steel
Cor exterior Color exterior Couleur extérieur Colour outer side	Imitação aço corten Imitación acero corten Imitation acier corten Corten steel imitation	RAL 9010	RAL 7016	Imitação de madeira escura Imitación de madera oscura Imitation de bois foncé Dark wood imitation	Imitação madeira clara Imitación de madera clara Imitation de bois clair Light wood imitation
Cara interior Cara interior Coté intérieur Inner side	Canelado stucco aço Acanalado stucco acero Rainuré stucco acier Ribbed stucco steel	Canelado stucco aço Acanalado stucco acero Rainuré stucco acier Ribbed stucco steel	Canelado stucco aço Acanalado stucco acero Rainuré stucco acier Ribbed stucco steel	Canelado stucco aço Acanalado stucco acero Rainuré stucco acier Ribbed stucco steel	Canelado stucco aço Acanalado stucco acero Rainuré stucco acier Ribbed stucco steel
Cor interior Color interior Couleur intérieur Colour inner side	RAL 9010	RAL 9010	RAL 9010	RAL 9010	RAL 9010
Preço Luso 500 Precio Luso 500 Prix Luso 500 Price Luso 500	€/ ml	€/ ml	€/ ml	€/ ml	€/ ml
Preço Luso 610 Precio Luso 610 Prix Luso 610 Price Luso 610	€/ ml	€/ ml	€/ ml	€/ ml	€/ ml

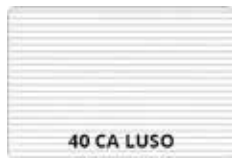

40 CA LUSO
LM Micro-Friso Liso
LM Microacanelado Liso
LM Micronervuré Lisse
LM Micro Ribbed Flat



40 LA LUSO
LM Friso Único Liso
LM Unicanalado Liso
LM Mono Ligne Lisse
LM Centre Ribbed S. Flat



40 LA LUSO
LM Friso Único Liso
LM Unicanalado Liso
LM Mono Ligne Lisse
LM Centre Ribbed S. Flat



40 LA LUSO
LM Friso Único Liso
LM Unicanalado Liso
LM Mono Ligne Lisse
LM Centre Ribbed S. Flat



40 LA LUSO
LM Friso Único Liso
LM Unicanalado Liso
LM Mono Ligne Lisse
LM Centre Ribbed S. Flat

Ref. Luso 500	53.500240	53.500230	53.500234	53.500233	2 Caras 53.500277
Ref. Luso 610	53.610240	_____	_____	_____	_____
Cara exterior	Micro-friso liso aço	Friso único liso aço	Friso único liso aço	Friso único liso aço	Friso único liso aço
Cara exterior	Microacanelado liso acero	Unicanalado liso acero	Unicanalado liso acero	Unicanalado liso acero	Unicanalado liso acero
Coté extérieur	Micronervuré lisse acier	Mono ligne lisse acier	Mono ligne lisse acier	Mono ligne lisse acier	Mono ligne lisse acier
Outer side	Micro ribbed flat steel	Centre ribbed flat steel	Centre ribbed flat steel	Centre ribbed flat steel	Centre ribbed flat steel
Cor exterior			Imitação de madeira escura	Imitação madeira clara	Imitação de madeira escura
Color exterior			Imitación de madera oscura	Imitación de madera clara	Imitación de madera oscura
Couleur extérieur	RAL 9010	RAL 9010	Imitation de bois foncé	Imitation de bois clair	Imitation de bois foncé
Colour outer side			Dark wood imitation	Light wood imitation	Dark wood imitation
Cara interior	Canelado stucco aço	Canelado stucco aço	Canelado stucco aço	Canelado stucco aço	Canelado liso aço
Cara interior	Acanalado stucco acero	Acanalado stucco acero	Acanalado stucco acero	Acanalado stucco acero	Acanalado liso acero
Coté intérieur	Rainuré stucco acier	Rainuré stucco acier	Rainuré stucco acier	Rainuré stucco acier	Rainuré lisse acier
Inner side	Ribbed stucco steel	Ribbed stucco steel	Ribbed stucco steel	Ribbed stucco steel	Ribbed flat steel
Cor interior					Imitação de madeira escura
Color interior	RAL 9010	RAL 9010	RAL 9010	RAL 9010	Imitación de madera oscura
Couleur intérieur					Imitation de bois foncé
Colour inner side					Dark wood imitation

Preço Luso 500					
Precio Luso 500	€ / ml	€ / ml	€ / ml	€ / ml	€ / ml
Prix Luso 500					
Price Luso 500					
Preço Luso 610					
Precio Luso 610	€ / ml	_____	_____	_____	_____
Prix Luso 610					
Price Luso 610					



40 LA LUSO
LM Friso Único Liso
LM Unicanalado Liso
LM Mono Ligne Lisse
LM Centre Ribbed S. Flat

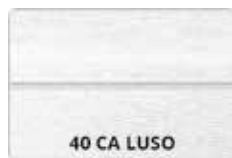

40 CA LUSO
LM Friso Único Woodgrain
LM Unicanalado Woodgrain
LM Mono Ligne Woodgrain
LM Centre Ribbed Woodgrain



40 CA LUSO
LM Friso Único Woodgrain
LM Unicanalado Woodgrain
LM Mono Ligne Woodgrain
LM Centre Ribbed Woodgrain



40 CA LUSO
LM Canelado Liso
LM Acanalado Liso
LM Rainuré Lisse
LM Ribbed S. Flat



40 CA LUSO
LM Canelado Liso
LM Acanalado Liso
LM Rainuré Lisse
LM Ribbed S. Flat

Ref. Luso 500	2 Caras 53.500276	53.500280	53.500282	53.500214	53.500213
Ref. Luso 610	_____	_____	_____	53.610214	53.610213
Cara exterior	Friso único liso aço	Friso único liso aço	Friso único liso aço	Canelado liso aço	Canelado liso aço
Cara exterior	Unicanalado liso acero	Unicanalado liso acero	Unicanalado liso acero	Acanalado liso acero	Acanalado liso acero
Coté extérieur	Mono ligne lisse acier	Mono ligne lisse acier	Mono ligne lisse acier	Rainuré lisse acier	Rainuré lisse acier
Outer side	Centre ribbed flat steel	Centre ribbed flat steel	Centre ribbed flat steel	Ribbed flat steel	Ribbed flat steel
Cor exterior	Imitação madeira clara			Imitação de madeira escura	Imitação madeira clara
Color exterior	Imitación de madera clara	RAL 9010	RAL 7016	Imitación de madera oscura	Imitación de madera clara
Couleur extérieur	Imitation de bois clair			Imitation de bois foncé	Imitation de bois clair
Colour outer side	Light wood imitation			Dark wood imitation	Light wood imitation
Cara interior	Friso único liso aço	Canelado stucco aço	Canelado stucco aço	Canelado stucco aço	Canelado stucco aço
Cara interior	Unicanalado liso acero	Acanalado stucco acero	Acanalado stucco acero	Acanalado stucco acero	Acanalado stucco acero
Coté intérieur	Mono ligne lisse acier	Rainuré stucco acier	Rainuré stucco acier	Rainuré stucco acier	Rainuré stucco acier
Inner side	Centre ribbed flat steel	Ribbed stucco steel	Ribbed stucco steel	Ribbed stucco steel	Ribbed stucco steel
Cor interior	Imitação madeira clara				
Color interior	Imitación de madera clara	RAL 9010	RAL 9010	RAL 9010	RAL 9010
Couleur intérieur	Imitation de bois clair				
Colour inner side	Light wood imitation				
Preço Luso 500					
Precio Luso 500	€ / ml	€ / ml	€ / ml	€ / ml	€ / ml
Prix Luso 500					
Price Luso 500					
Preço Luso 610					
Precio Luso 610	_____	_____	_____	€ / ml	€ / ml
Prix Luso 610					
Price Luso 610					

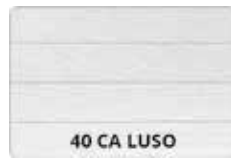

LM Canelado Liso
LM Acanalado Liso
LM Rainuré Lisse
LM Ribbed S. Flat

LM Canelado Liso
LM Acanalado Liso
LM Rainuré Lisse
LM Ribbed S. Flat

LM Canelado Woodgrain
LM Acanalado Woodgrain
LM Rainuré Woodgrain
LM Ribbed Woodgrain

LM Canelado Woodgrain
LM Acanalado Woodgrain
LM Rainuré Woodgrain
LM Ribbed Woodgrain

LM Canelado Woodgrain
LM Acanalado Woodgrain
LM Rainuré Woodgrain
LM Ribbed Woodgrain

Ref. Luso 500	2 Caras 53.500274	2 Caras 53.500273	53.500200	53.500206	53.500207
Ref. Luso 610	2 Caras 53.610274	2 Caras 53.610273	53.610200	53.610206	53.610207
Cara exterior Cara exterior Coté extérieur Outer side	Canelado liso aço Acanalado liso acero Rainuré lisse acier Ribbed flat steel	Canelado liso aço Acanalado liso acero Rainuré lisse acier Ribbed flat steel	Canelado woodgrain aço Acanalado woodgrain acero Rainuré woodgrain acier Ribbed woodgrain steel	Canelado woodgrain aço Acanalado woodgrain acero Rainuré woodgrain acier Ribbed woodgrain steel	Canelado woodgrain aço Acanalado woodgrain acero Rainuré woodgrain acier Ribbed woodgrain steel
Cor exterior Color exterior Couleur extérieur Colour outer side	Imitação de madeira escura Imitación de madera oscura Imitation de bois foncé Dark wood imitation	Imitação madeira clara Imitación de madera clara Imitation de bois clair Light wood imitation	RAL 9010	RAL 1015	RAL 9006
Cara interior Cara interior Coté intérieur Inner side	Canelado liso aço Acanalado liso acero Rainuré lisse acier Ribbed flat steel	Canelado liso aço Acanalado liso acero Rainuré lisse acier Ribbed flat steel	Canelado stucco aço Acanalado stucco acero Rainuré stucco acier Ribbed stucco steel	Canelado stucco aço Acanalado stucco acero Rainuré stucco acier Ribbed stucco steel	Canelado stucco aço Acanalado stucco acero Rainuré stucco acier Ribbed stucco steel
Cor interior Color interior Couleur intérieur Colour inner side	Imitação de madeira escura Imitación de madera oscura Imitation de bois foncé Dark wood imitation	Imitação madeira clara Imitación de madera clara Imitation de bois clair Light wood imitation	RAL 9010	RAL 9010	RAL 9010

Preço Luso 500 Precio Luso 500 Prix Luso 500 Price Luso 500	€ / ml	€ / ml	€ / ml	€ / ml	€ / ml
Preço Luso 610 Precio Luso 610 Prix Luso 610 Price Luso 610	€ / ml	€ / ml	€ / ml	€ / ml	€ / ml



LM Canelado Woodgrain
LM Acanalado Woodgrain
LM Rainuré Woodgrain
LM Ribbed Woodgrain

LM Canelado Woodgrain
LM Acanalado Woodgrain
LM Rainuré Woodgrain
LM Ribbed Woodgrain

LM Canelado Woodgrain
LM Acanalado Woodgrain
LM Rainuré Woodgrain
LM Ribbed Woodgrain

LM Canelado Woodgrain
LM Acanalado Woodgrain
LM Rainuré Woodgrain
LM Ribbed Woodgrain

LM Canelado Woodgrain
LM Acanalado Woodgrain
LM Rainuré Woodgrain
LM Ribbed Woodgrain

Ref. Luso 500	53.500215	53.500211	53.500212	53.500201	53.500210
Ref. Luso 610	53.610215	53.610211	53.610212	53.610201	53.610210
Cara exterior Cara exterior Coté extérieur Outer side	Canelado woodgrain aço Acanalado woodgrain acero Rainuré woodgrain acier Ribbed woodgrain steel	Canelado woodgrain aço Acanalado woodgrain acero Rainuré woodgrain acier Ribbed woodgrain steel	Canelado woodgrain aço Acanalado woodgrain acero Rainuré woodgrain acier Ribbed woodgrain steel	Canelado woodgrain aço Acanalado woodgrain acero Rainuré woodgrain acier Ribbed woodgrain steel	Canelado woodgrain aço Acanalado woodgrain acero Rainuré woodgrain acier Ribbed woodgrain steel
Cor exterior Color exterior Couleur extérieur Colour outer side	RAL 9007	RAL 7011	RAL 7016	RAL 6005	RAL 6009
Cara interior Cara interior Coté intérieur Inner side	Canelado stucco aço Acanalado stucco acero Rainuré stucco acier Ribbed stucco steel	Canelado stucco aço Acanalado stucco acero Rainuré stucco acier Ribbed stucco steel	Canelado stucco aço Acanalado stucco acero Rainuré stucco acier Ribbed stucco steel	Canelado stucco aço Acanalado stucco acero Rainuré stucco acier Ribbed stucco steel	Canelado stucco aço Acanalado stucco acero Rainuré stucco acier Ribbed stucco steel
Cor interior Color interior Couleur intérieur Colour inner side	RAL 9010	RAL 9010	RAL 9010	RAL 9010	RAL 9010

Preço Luso 500 Precio Luso 500 Prix Luso 500 Price Luso 500	€ / ml	€ / ml	€ / ml	€ / ml	€ / ml
Preço Luso 610 Precio Luso 610 Prix Luso 610 Price Luso 610	€ / ml	€ / ml	€ / ml	€ / ml	€ / ml



LM Canelado Woodgrain
LM Acanalado Woodgrain
LM Rainuré Woodgrain
LM Ribbed Woodgrain

LM Canelado Woodgrain
LM Acanalado Woodgrain
LM Rainuré Woodgrain
LM Ribbed Woodgrain

LM Canelado Woodgrain
LM Acanalado Woodgrain
LM Rainuré Woodgrain
LM Ribbed Woodgrain

LM Canelado Woodgrain
LM Acanalado Woodgrain
LM Rainuré Woodgrain
LM Ribbed Woodgrain

Ref. Luso 500	53.500202	53.500208	53.500209	53.500218
Ref. Luso 610	53.610202	53.610208	53.610209	53.610218
Cara exterior Cara exterior Coté extérieur Outer side	Canelado woodgrain aço Acanalado woodgrain acero Rainuré woodgrain acier Ribbed woodgrain steel	Canelado woodgrain aço Acanalado woodgrain acero Rainuré woodgrain acier Ribbed woodgrain steel	Canelado woodgrain aço Acanalado woodgrain acero Rainuré woodgrain acier Ribbed woodgrain steel	Canelado woodgrain aço Acanalado woodgrain acero Rainuré woodgrain acier Ribbed woodgrain steel
Cor exterior Color exterior Couleur extérieur Colour outer side	RAL 8014	RAL 5010	RAL 3000	RAL 9005
Cara interior Cara interior Coté intérieur Inner side	Canelado stucco aço Acanalado stucco acero Rainuré stucco acier Ribbed stucco steel	Canelado stucco aço Acanalado stucco acero Rainuré stucco acier Ribbed stucco steel	Canelado stucco aço Acanalado stucco acero Rainuré stucco acier Ribbed stucco steel	Canelado stucco aço Acanalado stucco acero Rainuré stucco acier Ribbed stucco steel
Cor interior Color interior Couleur intérieur Colour inner side	RAL 9010	RAL 9010	RAL 9010	RAL 9010
Preço Luso 500 Precio Luso 500 Prix Luso 500 Price Luso 500	€ / ml	€ / ml	€ / ml	€ / ml
Preço Luso 610 Precio Luso 610 Prix Luso 610 Price Luso 610	€ / ml	€ / ml	€ / ml	€ / ml



LM 80

LM Almfadado Woodgrain
LM Cuarterones Woodgrain
LM Cassette Woodgrain
LM Panelled Woodgrain

LM Sea

Canelado Aluminio
Acanalado Aluminio
Rainuré Aluminium
Ribbed Aluminium

Ref. Luso 500	53.580200	Esp. 210mm 53.500120 Esp. 300mm 53.500130	53.500252	53.500250
Ref. Luso 610	53.680200	Esp. 210mm 53.610120 Esp. 300mm 53.610130	53.610252	53.610250
Cara exterior Cara exterior Coté extérieur Outer side	Canelado stucco aço Acanalado stucco acero Rainuré stucco acier Ribbed stucco steel	Almfadado Woodgrain aço Cuarterones Woodgrain acero Cassette Woodgrain acier Panelled Woodgrain steel	Liso Woodgrain alumínio Liso Woodgrain aluminio Lisse Woodgrain aluminium Flat Woodgrain aluminium	Canelado stucco alumínio Acanalado stucco aluminio Rainuré stucco aluminium Ribbed stucco aluminium
Cor exterior Color exterior Couleur extérieur Colour outer side	RAL 9010	RAL 9010	RAL 9030	RAL 9030
Cara interior Cara interior Coté intérieur Inner side	Canelado stucco aço Acanalado stucco acero Rainuré stucco acier Ribbed stucco steel	Canelado stucco aço Acanalado stucco acero Rainuré stucco acier Ribbed stucco steel	Canelado stucco alumínio Acanalado stucco aluminio Rainuré stucco aluminium Ribbed stucco aluminium	Canelado stucco alumínio Acanalado stucco aluminio Rainuré stucco aluminium Ribbed stucco aluminium
Cor interior Color interior Couleur intérieur Colour inner side	RAL 9010	RAL 9010	RAL 9030	RAL 9030
Preço Luso 500 Precio Luso 500 Prix Luso 500 Price Luso 500	€ / ml	€ / ml	€ / ml	€ / ml
Preço Luso 610 Precio Luso 610 Prix Luso 610 Price Luso 610	€ / ml	€ / ml	€ / ml	€ / ml

VISORES

MIRILLAS / HUBLOTS / GLAZING

LM LINE

VISOR DE ALUMÍNIO LACADO / MIRILLA DE ALUMINIO LACADO / HUBLOT EN ALUMINIUM LAQUÉ / LACQUERED ALUMINIUM WINDOW

- Visor com tamanho máximo de 1500x350mm, lacado á cor da porta.
Preço sob consulta.
- Visor con un tamaño máximo de 1500 x 350 mm, lacado del mismo color que la puerta.
Precio a consultar.
- Volet de dimensions maximales 1500 x 350 mm, laqué dans la couleur de la porte.
Prix sur demande.
- Display with maximum size of 1500x350mm, lacquered in the same colour as the door.
Price on request.



VISORES DE ALUMÍNIO E AÇO INOX

MIRILLA DE ALUMINIO Y ACERO INOXIDABLE / HUBLOTS EN ALUMINIUM ET EN ACIER INOXYDABLE
ALUMINIUM AND STAINLESS STEEL SIGHT



290x290mm

Alumínio, fosco
Aluminio, translucido
Aluminium, opaque
Frosted, aluminium



330mm Ø

Aço inox, transparente
Acero inox, transparente
Acier inoxydable, transparent
Stainless steel, transparent



310x310mm

Aço inox, transparente
Acero inox, transparente
Acier inoxydable, transparent
Stainless steel, transparent

VISORES ACRÍLICOS

MIRILLAS ACRÍLICAS / HUBOLT ACRYLIQUE / ACRYLIC GLAZING



555x350mm

Simples, branco
Simple, blanco
Simple, blanc
Plain, white



370x205mm

Simples, branco
Simple, blanco
Simple, blanc
Plain, white



318mm Ø

Simples, branco
Simple, blanco
Simple, blanc
Plain, white



290x290mm

Simples, branco
Simple, blanco
Simple, blanc
Plain, white



726x326mm

Industrial grande
Industrial grande
Industriel grand
Big industrial



638x206mm

Industrial estreito
Industrial estrecha
Industriel étroit
Slim industrial



330mm Ø

Industrial redondo
Industrial redonda
Industriel rond
Round industrial

VISORES E VENTILADORES





MIRILLAS Y VENTILADORES / HUBLOTS ET GRILLES / GLAZING AND VENTILATION

Visor de alumínio lacado colocado na porta / medidas standard
Mirilla de aluminio lacado colocado en la puerta / medidas estándar
Hublot en aluminium laqué fixé sur la porte / dimensions standard
Lacquered aluminium window installed on door / standard sizes



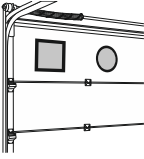

	NS.606722	Vidro duplo fosco, Colocado Vidrio doble mate, instalado Verre double opaque, installé Frosted double glazing, installed	555x350mm	€/uni.	NS.606728	Vidro duplo fosco, Colocado Vidrio doble mate, instalado Verre double opaque, installé Frosted double glazing, installed	1200x350mm	€/uni.
	NS.606724	Vidro duplo fosco, Colocado Vidrio doble mate, instalado Verre double opaque, installé Frosted double glazing, installed	800x350mm	€/uni.	NS.606729	Vidro duplo fosco, Colocado Vidrio doble mate, instalado Verre double opaque, installé Frosted double glazing, installed	1500x350mm	€/uni.
	NS.606726	Vidro duplo fosco, Colocado Vidrio doble mate, instalado Verre double opaque, installé Frosted double glazing, installed	1000x350mm	€/uni.				

Medidas não standard sob consulta
Medidas no estándar mediante consulta
Dimensions hors standard sur demand
Non-standard sizes available on request



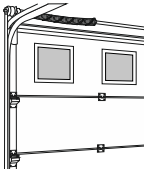

Visor de vidro, metálico incluído na porta
Mirilla de vidrio, metálica incluida en la puerta
Hublot de verre, en métal inclus dans la porte
Glass glazing, metal frame included in the door

	NS.606135	Visor em inox, redondo de vidro claro Mirilla inox, redonda con cristal transparente Hublot rond en inox, avec verre lisse Stainless steel, transparent round glazing		Ø330mm	€/uni.
	NS.606231	Visor em inox, quadrado de vidro claro Mirilla inox, cuadrado con cristal transparente Hublot carré en inox, avec verre lisse Stainless steel, transparent square glazing		310x310mm	€/uni.
	NS.610110	Visor alumínio, quadrado de vidro fosco Mirilla aluminio, cuadrado con cristal mate Hublot aluminium, verre opaque carré Aluminium, frosted glass square glazing		290x290mm	€/uni.

Visor quadrado de acrílico liso
Mirilla cuadrado de acrílico liso
Hublot carré d'acrylique lisse
Square plain acrylic glazing

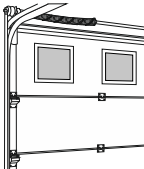
	NS.611011	branco blanco RAL 9010 white		290x290mm	€/uni.
	NS.611021	cromado cromado chrome chrome		290x290mm	€/uni.
	NS.611031	Imitação de madeira clara Imitación de madera clara Imitation bois clair Light timber coated design		290x290mm	€/uni.
	NS.611041	Imitação de madeira escura Imitación de madera oscura Imitation bois foncé Dark timber coated design		290x290mm	€/uni.

Visor quadrado de acrílico impresso
Mirilla cuadrado de acrílico granulado
Hublot carré d'acrylique granité
Square figured acrylic glazing

	NS.611012	branco blanco RAL 9010 white		290x290mm	€/uni.
	NS.611022	cromado cromado chrome chrome		290x290mm	€/uni.
	NS.611032	Imitação de madeira clara Imitación de madera clara Imitation bois clair Light timber coated design		290x290mm	€/uni.
	NS.611042	Imitação de madeira escura Imitación de madera oscura Imitation bois foncé Dark timber coated design		290x290mm	€/uni.

Visor redondo de acrílico liso
Mirilla redonda de acrílico liso
Hublot rond d'acrylique lisse
Round plain acrylic glazing

	NS.612001	branco blanco RAL 9010 white		Ø 318mm	€/uni.
------------------------------------------------------------------------------------	------------------	---------------------------------------	-------------------------------------------------------------------------------------	---------	--------

Visor simples de vidro incluído na porta
Mirilla de vidrio liso, suministrado con la puerta
Hublot de verre lisse, inclus dans la porte
Plain glass glazing, included with door

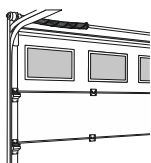

NS.606107	Vidro transparente Vidrio transparente Verre transparent Transparent glass	 555x350mm	€/uni.

Visor simples de vidro incluído na porta
Mirilla de vidrio liso, suministrado con la puerta
Hublot de verre lisse, inclus dans la porte
Plain glass glazing, included with door

NS.606104	Vidro espelhado Vidrio espejado Verre miroité Mirror glass	 555x350mm	€/uni.

NS.606105	Vidro impresso Vidrio granulado Verre granité Figured glass	 555x350mm	€/uni.

NS.606125	Visor laminado fosco Mirilla laminado mate Hublot laminé opaque Frosted laminated glazing	 555x350mm	€/uni.

Visor simples de acrílico, incluído na porta
Mirilla liso de acrílico, suministrado con la puerta
Hublot lisse d'acrylique, inclus dans la porte
Plain acrylic glazing, included with door

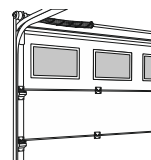

NS.606300	Visor transparente Mirilla transparente Hublot transparent Transparent glazing	 555x350mm	€/uni.

NS.606310	Visor transparente Mirilla transparente Hublot transparent Transparent glazing	 320x154mm	€/uni.

Visor de acrílico rectangular industrial, incluído na porta
Mirilla acrílico rectangular industrial, suministrado con la puerta
Hublot d'acrylique rectangulaire industriel, inclus dans la porte
Rectangular industrial acrylic glazing, included with door

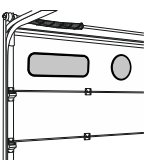

NS.606113	Visor claro grande Mirilla lisa Hublot lisse Plain glazing	 726x326mm	€/uni.

Visor de acrílico redondo industrial, incluído na porta
Mirilla acrílico redondo industrial, suministrado con la puerta
Hublot d'acrylique rond industriel, inclus dans la porte
Round industrial acrylic glazing, included with door

NS.606115	Visor claro Mirilla lisa Hublot lisse Plain glazing	 Ø 330mm	€/uni.

NS.606114	Visor claro estreito Mirilla lisa Hublot lisse Plain glazing	 638x206mm	€/uni.

Grelha de ventilação em PVC (int. + ext.), incluído na porta
Rejilla de ventilación simple de PVC (int. + ext.), suministrado con la puerta
Grille de ventilation simple en PVC (int. + ext.), inclus dans la porte
Regular ventilation grid of PVC (int. + ext.), included with door

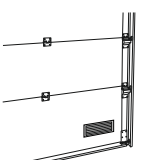



NS.605920	Ventilador branco, simples Ventilador blanco, simple Ventilateur blanc, simple Ventilation grid, white, standard	 250x100mm	€/uni.

Grelha de ventilação em PVC (int. + ext.), incluído na porta
Rejilla de ventilación simple de PVC (int. + ext.), suministrado con la puerta
Grille de ventilation simple en PVC (int. + ext.), inclus dans la porte
Regular ventilation grid of PVC (int. + ext.), included with door

NS.605924	Ventilador branco com rede, regulável Ventilador blanco con red, regulable Ventilateur blanc avec réseau, réglable White adjustable ventilation grid with mesh	 338x138mm	€/uni.

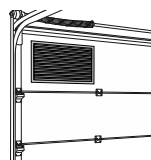
Grelha de ventilação em alumínio, incluído na porta
Rejilla de ventilación de aluminio, suministrado con la puerta
Grille de ventilation en aluminium, inclus dans la porte
Aluminium ventilation grid, included with door



NS.605910	Ventilador branco com caixilho Ventilador blanco con marco Ventilateur blanc avec encadrement White ventilation grid with frame	 505x305mm	€/uni.

Opção Acabamento de visor e ventilador
Opción Acabado de mirilla y ventilador
Option Finalisassion de hublot et ventilateur
Option Glazing and ventilation finishing



NS.PINTACC	Pintura RAL de caixilho/desenho/ventilador Pintura RAL de marco/deseño/ventilador Peinture RAL de cadre/dessin/ventilateur RAL painting of frame/cover design/grid	€/uni.

NS.PELÍCULA	Aplicação de película fosco Aplicación de la película translúcida Application du film dépoli Matt film application	€/uni.

NS.AB	Abertura de buraco em painel Apertura de agujero en panel Ouverture d'un trou dans le panneau Opening hole in panel	€/uni.

AUTOMAÇÃO

AUTOMACIÓN / AUTOMATION / AUTOMATION



SKY NX

MOTOR DE TETO
MOTOR DE TECHO
MOTEUR DE PLAFOND
CEILING MOTOR

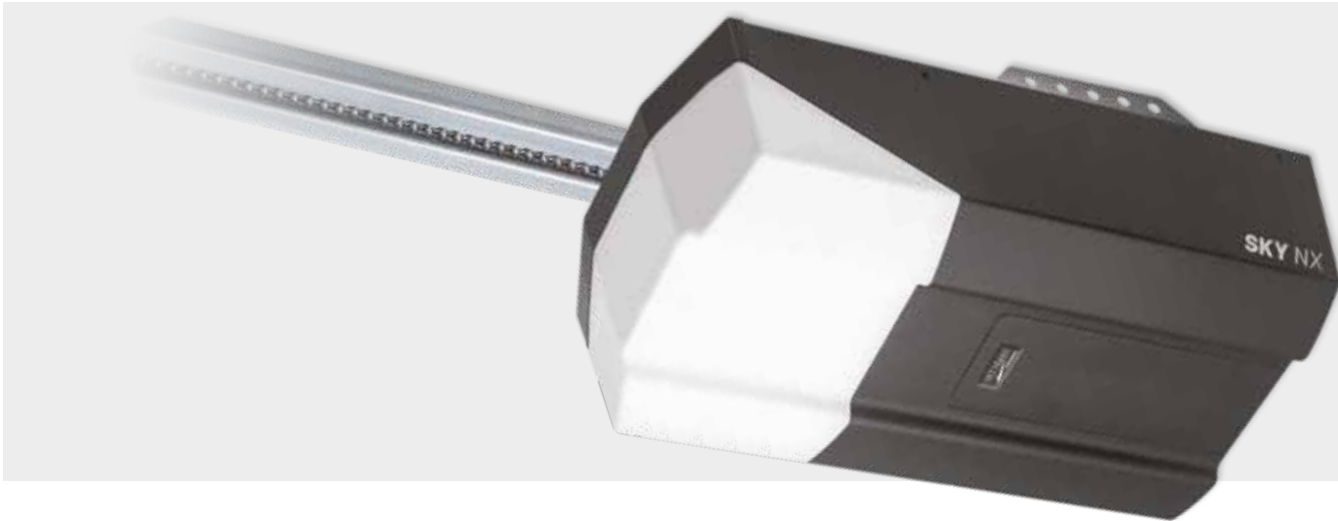

		600	1000	1200
Alimentação / Alimentación / Alimentation / Power supply	V AC	240	240	240
Motor / Motor / Moteur / Motor	V DC	24	24	24
Potência / Potencia / Puissance / Power	W	100	150	180
Torque / Torque / Moment de force / Torque	N.m	600	1000	1200
Velocidade / Velocidad / Vitesse / Speed	cm/s	16.0	16.0	14
Área máx. da porta / Tamaño máx. de puerta Taille max. de porte / Max. door size	m ²	10	15	18
Fusível / Fusible / Fusible / Fuse	A (2x)	2.5	2.5	2.5
Modo económico / Stand-by / Mise en veille / Standby	W	1	1	1
Temperatura/ Temperatura / Temperature / Temperature	°C	-40 ~ +50	-40 ~ +50	-40 ~ +50
Frequência / Frecuencia / Fréquence / Frequency	MHz	433 (50m)	433 (50m)	433 (50m)
Luz de cortesia / Luz de cortesía Éclairage de courtoisie / Courtesy light	(1x)	LED	LED	LED
Placa de controlo / Central de mando Logique de commande / Control board		integrada / integrada intégrée / integrated		

Para portas de altura até Para puertas con altura hasta Pour portes de hauteur jusqu'à For door heights up to	Com calha de corrente Con guía de cadena Avec rail à chaîne With chain rail
------------------------------------------------------------------------------------------------------------------------	--------------------------------------------------------------------------------------

Kit SKY NX 600

02.606300	2150mm [*]	€/kit
02.606310	2300mm	€/kit
02.606330	2450mm	€/kit
02.606360	2750mm	€/kit

Kit SKY NX 1000

02.610300	2150mm [*]	€/kit
02.610310	2300mm	€/kit
02.610330	2450mm	€/kit
02.610360	2750mm	€/kit
02.610400	3150mm	€/kit
02.610430	3450mm	€/kit
02.610500	4150mm	€/kit

Kit SKY NX 1200

02.612300	2150mm [*]	€/kit
02.612310	2300mm	€/kit
02.612330	2450mm	€/kit
02.612360	2750mm	€/kit
02.612400	3150mm	€/kit
02.612430	3450mm	€/kit
02.612500	4150mm	€/kit

* Calha Bipartida / Calha Bipartida / Calha Bipartida / Calha Bipartida

F-330

MOTOR DE TETO
MOTOR DE TECHO
MOTEUR DE PLAFOND
CEILING MOTOR



CE



	F-330	
Alimentação / Alimentación / Alimentation / Power supply	V AC	230
Motor / Motor / Moteur / Motor	V DC	24
Potência / Potencia / Puissance / Power	W	90
Torque / Torque / Moment de force / Torque	N.m	600
Velocidade / Velocidad / Vitesse / Speed	cm/s	11.0
Área máx. da porta / Tamaño máx. de puerta Taille max. de porte / Max. door size	m2	8
Fusível / Fusible / Fusible / Fuse	A (2x)	2,5
Modo económico / Stand-by / Mise en veille / Standby	W	4
Temperatura/ Temperatura / Temperature / Temperature	°C	-20 ~ +50
Frequência / Frecuencia / Fréquence / Frequency	MHz	433 (50m)
Luz de cortesia / Luz de cortesía Éclairage de courtoisie / Courtesy light	(1x)	LED
Placa de controlo / Central de mando Logique de commande / Control board	integrada / integrada intégrée / integrated	

	Para portas de altura até Para puertas con altura hasta Pour portes de hauteur jusqu'à For door heights up to	Com calha de corrente Con guía de cadena Avec rail à chaîne With chain rail
Kit F-330 SkyMaster		
02.479230	2240mm	€/kit
02.479233	2540mm	€/kit

F-350

MOTOR DE TETO
MOTOR DE TECHO
MOTEUR DE PLAFOND
CEILING MOTOR



CE



	F-350M F-350G		
Alimentação / Alimentación / Alimentation / Power supply	V AC	230	230
Motor / Motor / Moteur / Motor	V DC	24	24
Potência / Potencia / Puissance / Power	W	100	150
Intensidade / Absorción / Intensité / Absorption		0.43	0.65
Torque / Torque / Moment de force / Torque	N.m	700	1100
Velocidade / Velocidad / Vitesse / Speed	cm/s	11.0	11.0
Área máx. da porta / Tamaño máx. de puerta Taille max. de porte / Max. door size	m ²	10	15
Fusível / Fusible / Fusible / Fuse	A (2x)	2.5	2.5
Modo económico / Stand-by / Mise en veille / Standby	W	4	4
Temperatura / Temperatura / Temperature / Temperature	°C	-20 ~ +50	-20 ~ +50
Frequência / Frecuencia / Fréquence / Frequency	MHz	433 (50m)	433 (50m)
Luz de cortesia / Luz de cortesía Éclairage de courtoisie / Courtesy light	(1x)	LED	LED
Placa de controlo / Central de mando Logique de commande / Control board		integrada / integrada intégrée / integrated	

Para portas de altura até Para puertas con altura hasta Pour portes de hauteur jusqu'a For door heights up to	Com calha de corrente Con guía de cadena Avec rail à chaîne With chain rail
------------------------------------------------------------------------------------------------------------------------	--------------------------------------------------------------------------------------

Kit F-350M SkyMaster

02.487301	2200mm	€/kit
02.487331	2500mm	€/kit
02.487361	2800mm	€/kit
02.487431	3500mm	€/kit

Para portas de altura até Para puertas con altura hasta Pour portes de hauteur jusqu'a For door heights up to	Com calha de corrente Con guía de cadena Avec rail à chaîne With chain rail
------------------------------------------------------------------------------------------------------------------------	--------------------------------------------------------------------------------------

Kit F-350G SkyMaster

02.410301	2200mm	€/kit
02.410331	2500mm	€/kit
02.410361	2800mm	€/kit
02.410431	3500mm	€/kit

F-390

MOTOR DE TETO
MOTOR DE TECHO
MOTEUR DE PLAFOND
CEILING MOTOR



CE



	F-390G	
Alimentação / Alimentación / Alimentation / Power supply	V AC	230
Motor / Motor / Moteur / Motor	V DC	24
Potência / Potencia / Puissance / Power	W	200
Torque / Torque / Moment de force / Torque	N.m	1200
Velocidade / Velocidad / Vitesse / Speed	cm/s	11.0
Área máx. da porta / Tamaño máx. de puerta Taille max. de porte / Max. door size	m2	18
Fusível / Fusible / Fusible / Fuse	A (2x)	2,5
Modo económico / Stand-by / Mise en veille / Standby	W	5
Temperatura/ Temperatura / Temperature / Temperature	°C	-20 ~ +50
Frequência / Frecuencia / Fréquence / Frequency	MHz	433 (50m)
Luz de cortesia / Luz de cortesía Éclairage de courtoisie / Courtesy light	(1x)	LED
Placa de controlo / Central de mando Logique de commande / Control board	integrada / integrada intégrée / integrated	

Para portas de altura até
Para puertas con altura hasta
Pour portes de hauteur jusqu'à
For door heights up to

Com calha de corrente
Con guía de cadena
Avec rail à chaîne
With chain rail

Kit F-390 SkyMaster

02.412431	3500mm	€/kit
02.412501	4300mm	€/kit

F-850T

MOTOR AO VEIO
MOTOR AL EJE
MOTEUR EN BOUT D'ARBRE
GEAR MOTOR



CE

230V
400V

ALU
RESISTANCE

SLIM

SAFETY
BREAK

	F-850T	
Tensão / Voltaje / Tension / Voltage	V AC	230
Potência / Potencia / Puissance / Power	W	370
Intensidade / Absorción / Intensité / Absorption	A	3.5
Torque / Torque / Moment de force / Torque	N.m	50
Acoplamento / Boca de eje / Emboîture d'arbre / Shaft sleeve	mm / "	25,4/1 "
Cabo alimentação / Cable de alimentación / Câble d'alimentation / Power cable	m	8
Fins de curso / Finales de carrera / Fin de course / Limit switches	mecânicos / mecánicos mécaniques / mechanical	
Sis. secundário / Sis. secundario / Sys. secondaire / Secondary system	cadernal / elevador de cadena treuil à chaîne / chain hoist	
Frequência / Frecuencia / Fréquence / Frequency	MHz	433 (50m)
Placa de controlo / Central de mando / Logique de commande / Control board	integrada / integrada intégrée / integrated	

Kit F-850 T SkyMaster

02.403110

com quadro integrado
con quadro interno
avec cadre intégré
with integrated board

€/kit

F-850BX / F-890BX / F-850E

MOTOR AO VEIO
MOTOR AL EJE
MOTEUR EN BOUT D'ARBRE
GEAR MOTOR



		F-850 BX	F-890 BX	F-850 E
Tensão / Voltaje / Tension / Voltage	V AC	230	380	230
Potência / Potencia / Puissance / Power	W	370	370	370
Intensidade / Absorción / Intensité / Absorption	A	35	1.9	3
Torque / Torque / Moment de force / Torque	N.m	50	90	50
Acoplamento / Boca de eje / Emboiture d'arbre / Shaft sleeve	mm / "	25,4/1	25,4/1	25,4/1
Altura máx. / Altura máx. / Hauteur max. / Max. height	m	8	8	8
Fins de curso / Finales de carrera / Fin de course / Limit switches		mecânicos / mecánicos mécaniques / mechanical		encoder encodeur
Sis. secundário / Sis. secundario / Sys. secondaire / Secondary system		cadernal / elevador de cadena treuil à chaîne / chain hoist		
Frequência / Frecuencia / Fréquence / Frequency	MHz	433 (50m)	433 (50m)	433 (50m)

Kit F-850 BX SkyMaster

com quadro VARIO externo
con quadro VARIO de pared
avec cadre VARIO externe
with VARIO control station

02.403120 €/kit

Kit F-890 BX SkyMaster

com quadro VARIO externo
con quadro VARIO de pared
avec cadre VARIO externe
with VARIO control station

02.403320 €/kit

Kit F-850 E SkyMaster

com quadro VARIO externo
con quadro VARIO de pared
avec cadre VARIO externe
with VARIO control station

02.403150 €/kit

F-140

MOTOR AO VEIO
MOTOR AL EJE
MOTEUR EN BOUT D'ARBRE
GEAR MOTOR



CE

400V

ALU
RESISTANCE

SLIM

SAFETY
BREAK

	F-140	
Tensão / Voltaje / Tension / Voltage	V AC	400
Potência / Potencia / Puissance / Power	W	400
Intensidade / Absorción / Intensité / Absorption	A	1,9
Torque / Torque / Moment de force / Torque	N.m	140
Acoplamento / Boca de eje / Emboiture d'arbre / Shaft sleeve	mm / "	25,4
Altura máx. / Altura máx. / Hauteur max. / Max. height	m	11
Fins de curso / Finales de carrera / Fin de course / Limit switches	encoder / encodeur	
Sis. secundário / Sis. secundario / Sys. secondaire / Secondary system	cadernal / elevador de cadena treuil à chaîne / chain hoist	
Frequência / Frecuencia / Fréquence / Frequency	MHz	433 (50m)

Kit F-140 SkyMaster

02.401573 com quadro JUMBO externo
con quadro JUMBO de pared
avec cadre JUMBO externe
with JUMBO control station €/kit

OPÇÕES E ACESSÓRIOS



OPCIONES Y ACCESORIOS / OPTIONS ET ACCESSOIRES / OPTIONS AND ACCESSORIES



02.400512

Kit segurança fotoeletrico sem fios
Kit de seguridad fotoeléctrico inalámbrico
Kit de sécurité photoélectrique sans fil
Wireless photoelectric security kit

€/kit



02.400511

Kit eletromagnetico para porta homem sem fios
Kit electromagnético para puerta de hombre inalámbrica
Kit électromagnétique pour porte homme sans fil
Wireless electromagnetic kit for wicket door

€/kit



02.400013

Selector digital sem fios
Teclado digital inalámbrico
Clavier numérique sans fil
Wireless digital selector

€/uni



02.400018

Selector digital sem fios
Teclado digital inalámbrico
Clavier numérique sans fil
Wireless digital selector

€/uni



02.400046

Seletor de Chave, GLOBDOOR
Selector de llave, GLOBDOOR
Sélécteur à la clé, GLOBDOOR
Keyswitch, GLOBDOOR

€/uni



02.401940

Botoneira 3 funções
Mando de pared 3 botones
Bouton mural 3 fonctions
3 functions push button

€/uni



02.400039

Emissor 'black+inox' 4 canais
Mando 'black+inox' 4 canales
Émetteur 'black+inox' 4 canaux
Emitter 'black+inox' 4 channels

€/uni



02.400002

Botoneira de parede sem fios
Mando de pared inalámbrica
Bouton mural sans fil
Wireless push button station

€/uni



02.400033

Fotocélulas de parede
Fotocélulas de pared
Photocellules murales
Wall photocells

€/uni



02.400055

Fotocélulas de espelho
Fotocélulas de espejo
Photocellules miroir
Mirror photocells

€/uni



02.400028

Pirilampo 230v / 24v led com antena
Lámpara de destellos 230v / led 24v con antena
Feu clignotant à 230v / led 24v avec antenne
230v flasher / 24v led flasher with antenna

€/uni



02.400035

Desembriador externo com chave
Desbloqueo exterior con llave
Débrayage externe à clé
External key release

€/uni

ENCOMENDAS

PEDIDOS / COMMANDES / ORDERS

PT

As encomendas à LM Perfis podem ser formalizadas pelos meios que lhe colocamos à disposição e implicam a aceitação, na íntegra, das Condições Gerais de Venda. Se, após aceitação, uma encomenda for alterada ou anulada, recairá sobre o Cliente o custo correspondente a 25% do valor de fatura dos itens já produzidos.

FR

Les commandes faites à LM Perfis peuvent être formalisées par les moyens mis à disposition et impliquent l'acceptation, dans sa totalité, des Conditions Générales de Vente.

Si après réception une commande est modifiée ou annulée, le Client en assumera l'entière responsabilité et devra payer le coût correspondant à 25% de la valeur facturée des items produits.

ES

Los Pedidos a la LM Perfis pueden ser formalizados por los medios que ponemos a su disposición e implican la aceptación, en su totalidad, de las Condiciones Generales de Venta.

Si, después de la aceptación, el pedido se cambia o se cancela, recaerá sobre el Cliente lo coste de 25% del valor de la factura de los elementos ya producidos.

EN

Orders placed to LM Perfis may be formalized by the means which we provide and require the complete acceptance of the General Terms of Sale.

If, after acceptance, an order is amended or revoked, the Customer will be charged 25% of invoice value for all the items subject to production.

CONTACTOS

CONTACTO / CONTACT / CONTACTS

PT / Orçamentos	orcamentos@lmpenfis.pt
ES / Presupuestos	presupuestos@lmpenfis.pt presupuestos2@lmpenfis.pt
FR / Devis	france@lmpenfis.pt
EN / Quotations	orcamentos@lmpenfis.pt
PT / Encomendas	encomendas@lmpenfis.pt
ES / Pedidos	pedidos@lmpenfis.pt
FR / Commandes	france@lmpenfis.pt
EN / Orders	encomendas@lmpenfis.pt

Telefone Geral / Teléfono General / Téléphone Général / General Telephone +351 236 620 170

Tel. Automatismos / Tel. Automatismos / Tel. Automatismes / Automation Tel. +351 236 028 018
+351 236 028 020

TRANSPORTE

ENTREGAS / LIVRAISON / DELIVERY

PT

Os prazos de fornecimento de material são dados, salvo expresso acordo, a título meramente indicativo (ver art. 7 das Condições Gerais de Venda).
Os custos com o transporte ficam a cargo do cliente, de acordo com a tabela de preços em vigor.

ES

Los plazos de suministro de mercancías son dados solamente como indicativos, a menos que se acuerde expresamente otros (ver art. 7 de las Condiciones Generales de Venta).
Los costes del transporte corren a cargo del Cliente, de acuerdo con la tarifa en vigor.

FR

Les délais de livraison de matériel sont, sauf accord prévu, purement indicatifs (voir article 7 des Conditions Générales de Vente).
Les coûts liés au transport sont à la charge du Client, conformément aux tarifs en vigueur.

EN

The given delivery deadlines are general estimations, unless otherwise stated (see art. 7 of the General Terms of Sale).
Shipping costs will be charged to the customer, according to the last price list.

APOIO AO CLIENTE

SERVICIO AL CLIENTE / SERVICE CLIENT / CUSTOMER SERVICE

PT

Contacte-nos em caso de qualquer dúvida, informação ou reclamação. Teremos todo o gosto em lhe prestar o apoio necessário.

ES

Contáctenos para cualquier tipo de aclaración, sugerencia o reclamación. Nos encanta proporcionarle todo el apoyo necesario.

FR

Contactez-nous en cas d'incertitude, d'information ou réclamation. Nous aurons tous le plaisir de vous fournir l'aide nécessaire.

EN

Contact us if you have any questions, requests of information or complaints. We will be happy to provide you with the necessary support.

CONTACTOS

CONTACTO / CONTACT / CONTACTS

Dep. Comercial / Dep. Comercial / Service Commercial / Sales Dept.

comercial@Imperfis.pt

Dep. Apoio ao Cliente / Apoio al cliente / Dep. SAV / Customer Care Dept.

apoiocliente@Imperfis.pt

**Dep. Design e Marketing / Dep. Design y marketing
Dép. Design et Marketing / Design and Marketing Dept.**

design@Imperfis.pt

**Dep. Automatismos / Dep. Automatismos
Ser. Automatismes / Automation Dept.**

automatismos@Imperfis.pt

NOTAS

NOTAS / NOTES / NOTES

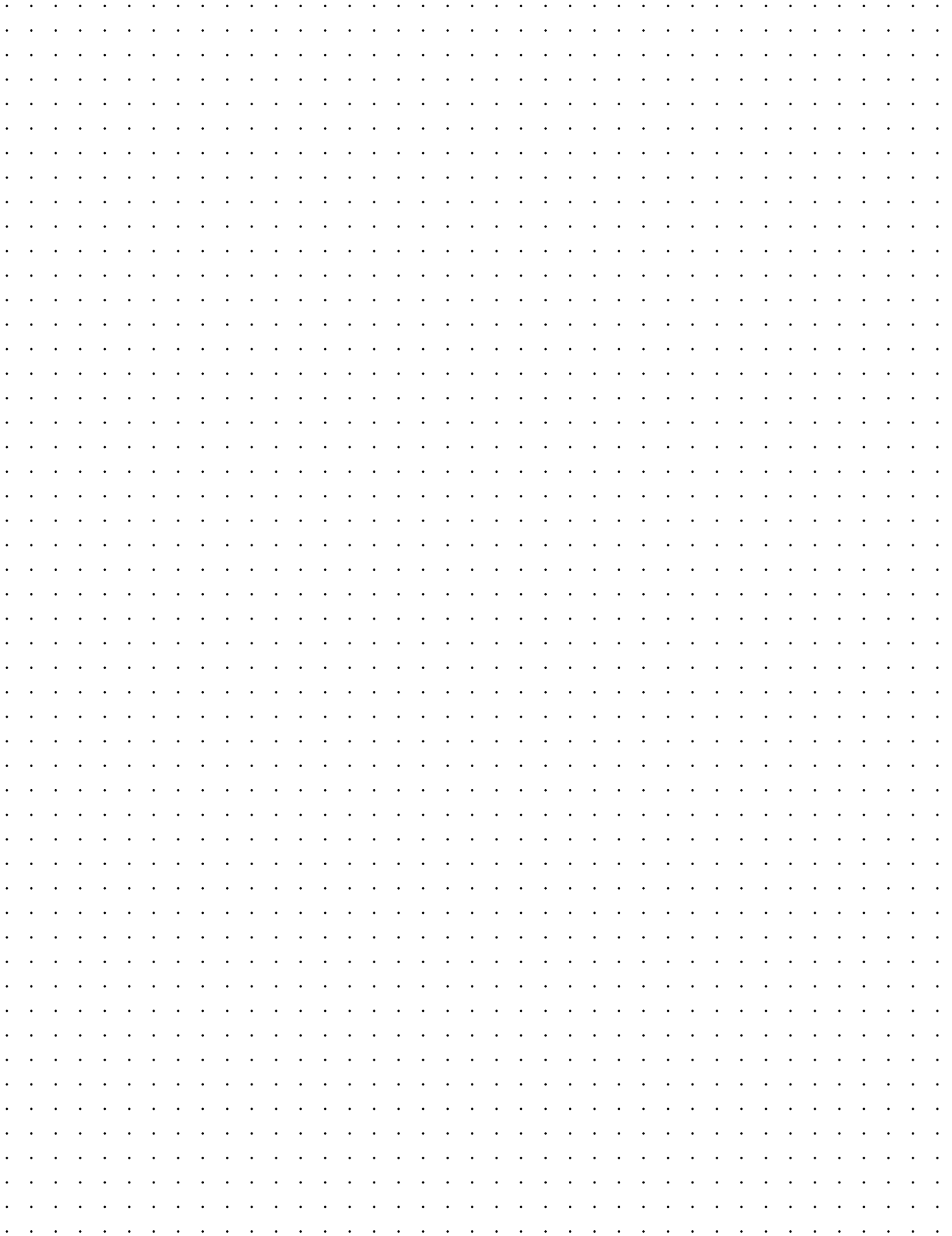

Técnico Comercial / Técnico Comercial
Technicien Commercial / Sales Technician

Telemóvel / Teléfono móvil
Téléphone portable / Mobile phone

Email

- Em vigor a partir de 01-04-2026. / Preços sujeitos a IVA à taxa legal em vigor. Toda a informação contida neste documento está sujeita a alterações sem aviso prévio.
- En vigor desde el 01-04-2026. / Los precios están sujetos a la tasa de IVA legal vigente. Toda la información aquí contenida está sujeta a cambios sin previo aviso.
- En vigueur à partir du 01-04-2026. / Les prix sont soumis à la TVA en vigueur. Toute l'information contenue dans ce document est sujette à changement sans préavis.
- Effective 01-04-2026. / Prices are subject to the legal VAT rate in effect. The right is reserved to change prices and specifications without prior notice.

CERTIFICAÇÃO



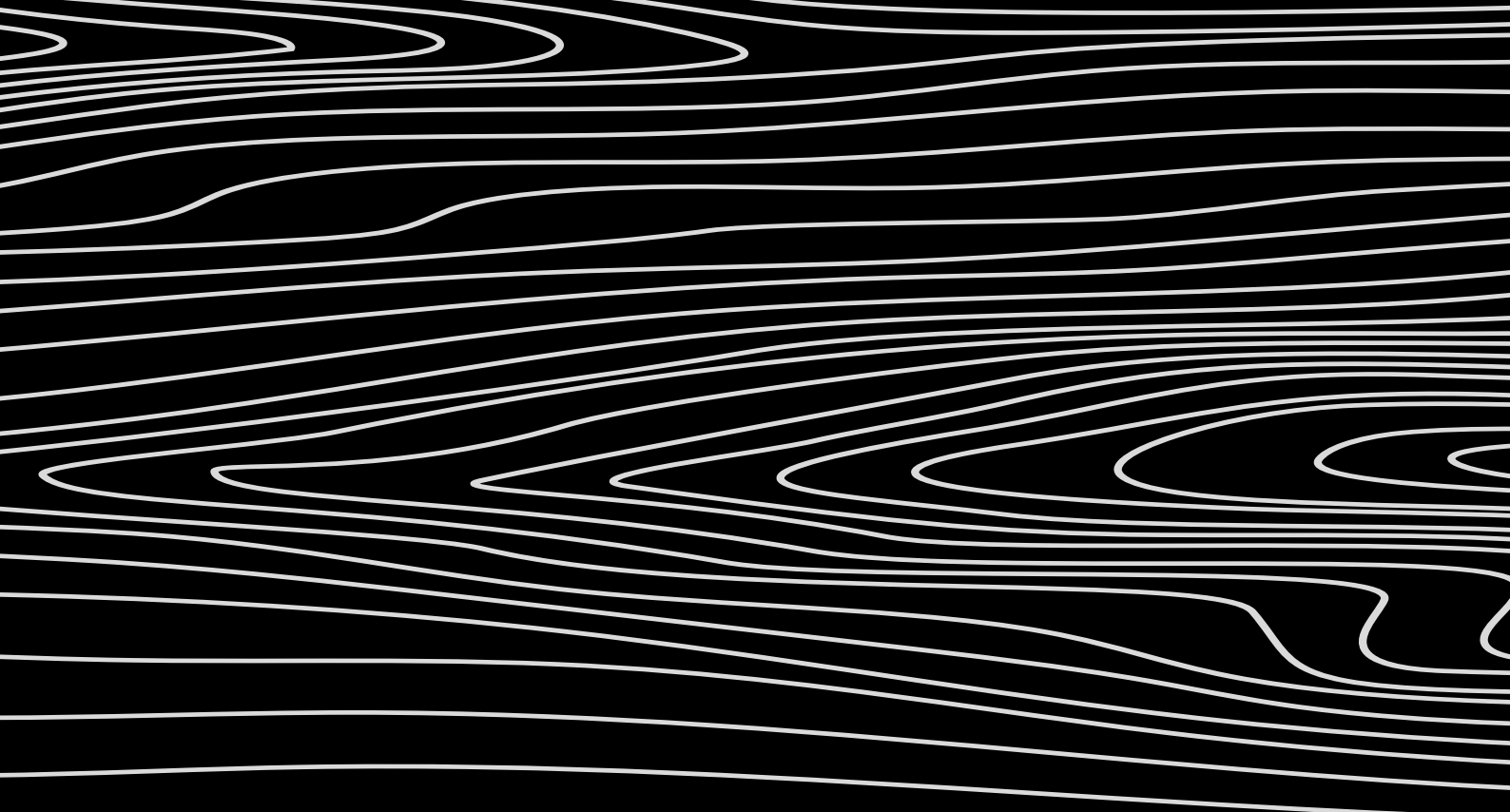

 **LM PERFIS**
INDÚSTRIA DE PERFIS E PORTAS, S.A.

Zona Industrial do Camporês, Rua Azul
Lote 26-27 / Chão de Couce
3240 - 509 Ansião / Portugal

t +351 236 620 170
info@lmpervis.pt
www.lmpervis.pt

